

# User guide

---

SMHX (SM32HX-P, SM55HX-P, SM85HX-P)

---

The colour and the appearance may differ depending on the product, and the content in the manual is subject to change without prior notice to improve the performance.

An administration fee may be charged in the following situations:

- (a) An engineer is called out at your request, but it is found that the product has no defect (i.e., where the user manual has not been read).
- (b) You bring the unit to a repair centre, but it is found that the product has no defect (i.e., where the user manual has not been read).

You will be informed of the administration fee amount before a technician visits.

---

# Table of contents

## Before Using the Product

---

Safety Precautions	4
Safety symbols	4
Electricity and Safety	5
Installation	6
Operation	7
Precautions when handling the panel	9
Cleaning	9

---

Storage and Maintenance	10
-------------------------	----

## Preparations

---

Checking the Components	11
-------------------------	----

---

Parts	12
SM32HX-P	12
SM55HX-P / SM85HX-P	13

---

Ports	14
SM32HX-P	14
SM55HX-P / SM85HX-P	15

---

Control menu	16
--------------	----

---

Remote Control	17
----------------	----

---

Before Installing the Product (Installation Guide)	19
Ventilation	19
Optimal Viewing Distance and Height	19

---

Installing the Wall Mount	20
Preparing before installing Wall-Mount	20
Installing the Wall Mount	20
Wall Mount Kit Specifications (VESA)	21

## Connecting and Using a Source Device

---

Before Connecting	22
Pre-connection Checkpoints	22

---

Connecting to a PC	22
Connection Using an HDMI Cable	22
Connection Using an DP Cable	23

---

Connecting to a Video Device	23
Connection Using an HDMI Cable	23

---

Connecting HDMI to Sound system and Video device	24
--	----

---

Connecting to an Audio system	24
-------------------------------	----

---

Connecting the LAN Cable	24
--------------------------	----

---

Changing the Input source Sources	25
-----------------------------------	----

## Multiple Display Control

---

Cable Connection	26
RS232C Cable	26
LAN Cable	27
Connection	29
Control Codes	30

---

Using MDC	37
MDC Programme	
Installation/Uninstallation	37

---

# Table of contents

## Home Screen

---

Favourites	38
Features	39
MagicInfo	40
Schedule	46
Web browser	47
Custom Home	50
Screen Mirroring	51
Workspace	52
SMARTVIEW+	53
APPS	54
Settings	55
Network	55
Clone Product	56
ID Settings	57
Video Wall	58
On/Off Timer	60
Ticker	62

## Menu

---

Picture	63
OnScreen Display	67
Sound	69
Network	71
Network Settings (Wired)	72
Network Settings (Wireless)	74
Use WPS	76
System	80
Support	92

## Troubleshooting Guide

---

Requirements Before Contacting Samsung Customer Service Centre	94
Testing the Product	94
Checking the Resolution and Frequency	94
Check the followings.	95

## Specifications

---

General	101
Preset Timing Modes	103

## Appendix

---

Responsibility for the Pay Service (Cost to Customers)	105
Not a product defect	105
A Product damage caused by customer's fault	105
Others	105
Prevention of Afterimage Burn-in	106
What is afterimage burn-in?	106
Recommended prevention practices	106
Licence	107





# Chapter 01







## Before Using the Product

### Safety Precautions

The following safety instructions are to ensure your personal safety and prevent property damage. Please read the following to ensure the proper use of the product.

#### Safety symbols







Symbol	Name	Meaning
	Warning	A serious or fatal injury may result if instructions are not followed.
	Caution	Personal injury or damage to properties may result if instructions are not followed.
	Prohibition	Do NOT attempt.
	Instruction	Follow directions.

CAUTION			
RISK OF ELECTRIC SHOCK. DO NOT OPEN.			
CAUTION: TO REDUCE THE RISK OF ELECTRIC SHOCK, DO NOT REMOVE COVER (OR BACK). THERE ARE NO USER SERVICEABLE PARTS INSIDE. REFER ALL SERVICING TO QUALIFIED PERSONNEL.			
	This symbol indicates that high voltage is present inside. It is dangerous to make any kind of contact with any internal part of this product.		AC voltage: Rated voltage marked with this symbol is AC voltage.
	This symbol indicates that this product has included important literature concerning operation and maintenance.		DC voltage: Rated voltage marked with this symbol is DC voltage.
	Class II product: This symbol indicates that a safety connection to electrical earth (ground) is not required. If this symbol is not present on a product with a mains lead, the product MUST have a reliable connection to protective earth (ground).		Caution. Consult instructions for use: This symbol instructs the user to consult the user manual for further safety related information.





---

## Electricity and Safety

### Warning

-  Do not handle the power plug with a wet body part.  
Otherwise, an electric shock may result.
-  Do not bend or pull the power cord with force. Be careful not to leave the power cord under a heavy object.  
Product failure, an electric shock or fire may result from a damaged cable.
-  Do not connect multiple products to a single power socket.  
Overheated power sockets may cause a fire.
-  Do not use a damaged power plug or a loose power socket.  
An electric shock or fire may result.
-  Insert the power plug all the way in so it is not loose.  
An unsecure connection may cause a fire.
-  Clean any dust around the pins of the power plug or the power socket with a dry cloth.  
A fire may result.
-  Connect the power plug to a grounded power socket. (Except for devices that do not provide grounding)  
An electric shock or injury may result.



### Caution

-  Hold the plug when disconnecting the power cord from the power socket.  
An electric shock or fire may result.
-  Do not disconnect the power cord while the product is being used.  
The product may become damaged by an electric shock.
-  When connecting the power plug to the port, be sure to connect it completely.  
If the power plug is not completely connected to the port, the plug may be unexpectedly disconnected, or there is a risk of overheating due to overcurrent, leading to safety accidents.
-  Only use the power cord provided with your product by Samsung. Do not use the power cord with other products.  
An electric shock or fire may result.
-  Keep the power socket where the power cord is connected unobstructed.  
When a problem occurs with the product, the power cord must be unplugged to completely cut off power to the product. Note that the product is not completely powered down by using only the power button on the remote.



---

## Installation

### Warning

-  Do not install the product in a poorly ventilated space such as bookcase or closet.  
An increased internal temperature may cause a fire.
-  Discard the plastic packaging that the product is packaged in, immediately after unpacking.  
Plastic packaging material can cause suffocation if it is handled improperly.
-  Do not install the power cord (DC power supply) and the product near heat sources.  
(Candles, mosquito repellents, cigarettes, sprays, heating devices, places exposed to direct sunlight, and more)
-  When installing the product, fix it firmly so that it does not fall.  
If the product is handled incorrectly, it may fall and be damaged or cause injury.
-  Do not install the product in a kitchen or near a kitchen counter.  
Edible oil or oil vapor can damage or deform the product.
-  Before moving the product, turn off the power switch and disconnect the power cord and all other connected cables.  
Damage to the cable may cause a fire or electric shock.
-  When installing the product, keep it at a distance from the wall so that it is well ventilated.  
An increased internal temperature may cause a fire.
-  Have a technician install the wall-mount hanger.  
Installation by an unqualified person can result in an injury. Only use approved cabinets.
-  If the product is installed in an unusual location, the surrounding environment may cause a serious quality problem. Therefore, be sure to contact Samsung Customer Service Centre before installation.  
(Places with high levels of fine dust, areas where chemicals are used, locations with extremely high or low temperatures, humid or wet environments, vehicles or other means of transportation, industrial sites such as metal processing plants or stations where metal dust may be present.)









### Caution









-  Do not lay down the product on its front.  
The screen may become damaged.
-  Prolonged exposure to direct sunlight may discolour the surface of the screen display.
-  Do not drop the product while moving.  
The product may fall, causing personal injury or product damage.

---

## Operation







### Warning







-  Exercise caution when storing the remote control batteries and small accessories, so they are not swallowed.  
If swallowed, consult a physician immediately.
-  If the product is dropped or its appearance is damaged, turn off the power switch and disconnect the power cord. Then contact Samsung Customer Service Centre.  
Continued use can result in an electric shock or a fire.
-  Do not move the product by pulling the power cord or any cable.  
Product failure, an electric shock or fire may result from a damaged cable.
-  Ensure the vents are not blocked by tablecloths or curtains.  
An increased internal temperature may cause a fire.
-  Do not apply an impact to the product.
  - The screen display may be damaged.
  - An electric shock or fire may result.
-  Do not insert metallic objects (chopsticks, coins, hairpins, etc) or objects that burn easily (paper, matches, etc) into the product (through the vent or input/output ports, etc).
  - If foreign substances enter the product, be sure to power off the product and disconnect the power cord. Then contact Samsung Customer Service Centre.
  - Product failure, an electric shock or fire may result.
-  Do not place objects containing liquid (vases, pots, bottles, etc) or metallic objects on top of the product.
  - If foreign substances such as water enter the product, be sure to disconnect the power cord. Then contact Samsung Customer Service Centre.
  - Product failure, an electric shock or fire may result.
-  During a lightning or thunderstorm, power off the product and disconnect the power cord.  
An electric shock or fire may result.

-  Do not put heavy objects, toys or snacks on top of the product.  
Hanging on to the product to get a toy or snack may cause heavy objects to fall or the product to tip over, resulting in injury or death.
-  Do not hang on or climb on the product.  
The product may fall, causing personal injury or even death.
-  While the power plug is plugged into a power socket, do not insert a chopstick or other conductor into a remaining power socket. Also, after disconnecting the power plug from the power socket, do not touch the pins of the plug immediately.  
Otherwise, an electric shock may result.
-  There is a high voltage inside the product. Never disassemble, repair or modify the product yourself.
  - Contact Samsung Customer Service Centre for repairs.
  - An electric shock or fire may result.
-  Do not use humidifiers or stoves around the product.  
An electric shock or fire may result.
-  Do not use liquid fumigators containing chemicals, such as mosquito repellent or air freshener, around the product.  
If steam comes in contact with the product surface or enters the product, it may cause stains or malfunction.
-  If the product generates a strange noise, a burning smell, or smoke, unplug the power plug immediately and contact your Samsung Customer Service Centre.  
An electric shock or fire may result.
-  If a gas leakage is found, do not touch the product or the power plug, and ventilate the room immediately.  
Sparks can cause an explosion or fire.

---

## Caution

-  **Do not place heavy objects on the product.**  
Product failure or personal injury may result.
-  **Use only the specified standardised batteries, and do not use a new battery and a used battery at the same time.**  
Otherwise, the batteries may be damaged or cause fire, personal injury or damage due to a leakage of the internal liquid.
-  **Do not watch the product screen too closely and continuously for a long time.**  
Your eyesight may deteriorate.
-  **Do not lift or move the product when it is in operation.**
-  **Do not touch the screen when the product has been turned on for an extended period of time as it will become hot.**
-  **When using headphones or earphones, do not turn the volume too high or use them for a long time.**  
Damage to your hearing may result.

-  **Insert each battery so that its polarity (+, -) is correct.**  
If the polarity is not correct, the battery may rupture or the internal fluid may leak, causing contamination and damage to the surroundings, fire, or personal injury.
-  **When you do not use the product for a long time due to vacation or other reason, disconnect the power cord from the power socket.**  
Dust accumulation combined with heat can cause a fire, electric shock or electric leakage.
-  **Use the product at the recommended resolution and frequency.**  
Your eyesight may deteriorate.
-  **The batteries (and rechargeable batteries) are not ordinary refuse and must be returned for recycling purposes. The customer is responsible for returning the used or rechargeable batteries for recycling.**  
The customer can return used or rechargeable batteries to a nearby public recycling centre or to a store selling the same type of the battery or rechargeable battery.
-  **Take a break for at least 5 minutes after using the product for 1 hour.**
-  **Leaving the screen fixed on a stationary image for an extended period of time may cause afterimage burn-in or defective pixels.**  
When you do not use the product for a long time, activate power-saving mode or set the screen saver to moving-picture mode.
-  **Do not use or keep combustible spray or an inflammable substance near the product.**  
An explosion or fire may result.

## Precautions when handling the panel

 The colour and the appearance may differ depending on the model.

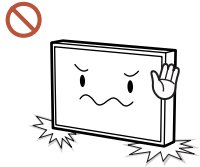

Do not stand the product as shown in the image. The panel is fragile and can get damaged.

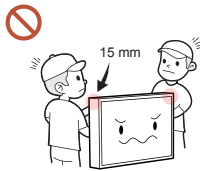

Do not hold or grasp any area of the product within 15 mm from the front.

## Cleaning

### Warning



Do not spray water or cleaner directly on the product.

- The product's surface may be damaged, or the markings may be erased.
- An electric shock or fire may result.

### Caution



Do not apply chemicals containing alcohol, solvent, or surfactant such as wax, benzene, thinner, pesticide, air freshener, lubricant, or cleaner to the product.

The product's exterior may be discoloured or cracked, the surface of the panel may be peeled off, or the markings may be erased.



When cleaning, be sure to disconnect the power plug and wipe gently with a soft and dry cloth such as superfine fibers or cotton flannels to prevent scratches.

The product's surface may be damaged, or the markings may be erased.



Be sure to use a soft and dry cloth such as superfine fibers or cotton flannels because the surface of the product and the screen display are vulnerable to scratches.

The product's surface or the screen display can be easily scratched with foreign substances.

## Storage and Maintenance

### Cleaning the exterior and display

Wipe the surface with a slightly wet, soft cloth, and then wipe with a dry cloth.

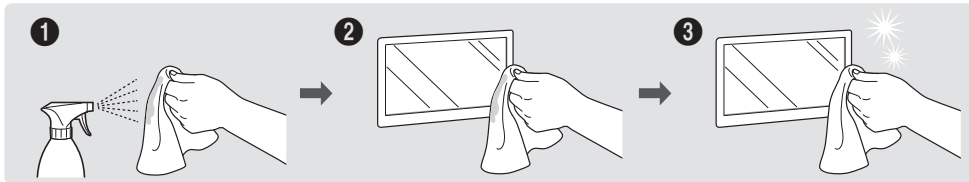

### Precautions

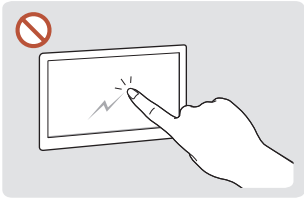

Do not scratch the screen with sharp objects. Scratches may leave marks or damage the product.

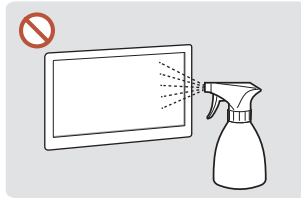

Do not spray water directly on any part of the product. Product failure, an electric shock or fire may result from water that enters the product.

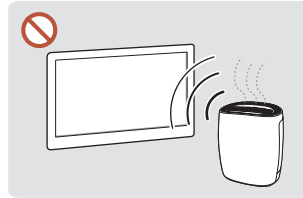

Due to the characteristics of high-glossy products, using a UV humidifier nearby may create white-coloured stains on the product.

- Removing a sticker attached on the screen may leave residues. Clean the residues before watching the screen.
- Do not strongly press and rub the product. Damage to the product may result.
- Do not wipe the screen with chemicals. Product failure may result.
- Contact Samsung Customer Service Centre if the inside of the product needs cleaning (service fee will be charged).
- We recommend using a clean cloth when touching the front panel, instead of a bare body part.

# Chapter 02

## Preparations

### Checking the Components

- Contact the vendor where you purchased the product if any components are missing.
- The appearance of the components may differ from the images shown.
- The RS232C adapter can be used to connect to another monitor using the D-SUB (9-pin) type RS232C cable.



Simple User Guide



Warranty card  
(Not available in some locations)



Regulatory guide



Waste Electrical & Electronic  
Equipment  
(Europe only)



Power cord

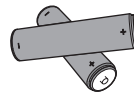

Batteries (AAA x 2)  
(Not available in some locations)



Remote Control

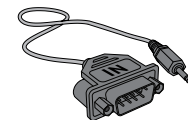

RS232C adapter

## Parts

### SM32HX-P

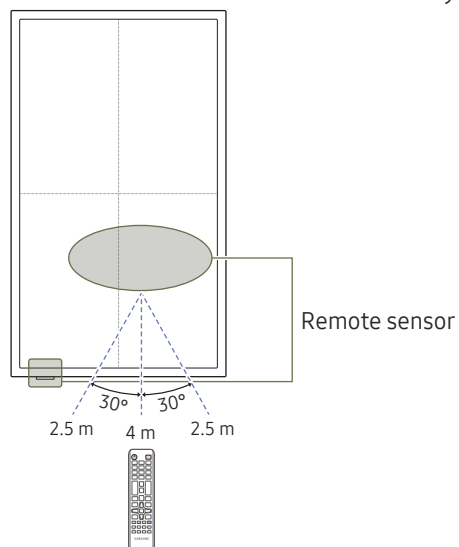
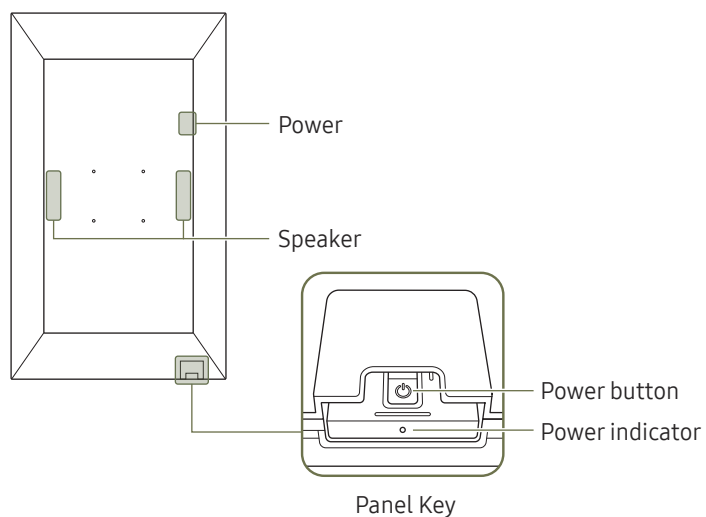

The colour and shape of parts may differ from what is shown. Specifications are subject to change without notice to improve quality.

Parts	Description	
Remote sensor	Press a button on the remote control pointing at the sensor on the front of the product to perform the corresponding function.	
	Using other display devices in the same space as the remote control of this product can cause the other display devices to be inadvertently controlled.	
		Use the remote sensor while holding down the sliding panel key.
Panel Key		To use the panel key, make sure the sliding panel key is not protruding from the bottom of the product.
Power button	Turns the product on or off.	

Remote sensor in the screen: Use the remote control within 2.5 m to 4 m from the sensor on the product at an angle of 30° from the left and right.

Remote sensor at the bottom: Use the remote control within 7 m to 10 m from the sensor on the product at an angle of 30° from the left and right.

To enhance the IR receiver performance, connect an external IR cable (sold separately) to the IR IN port.

## SM55HX-P / SM85HX-P

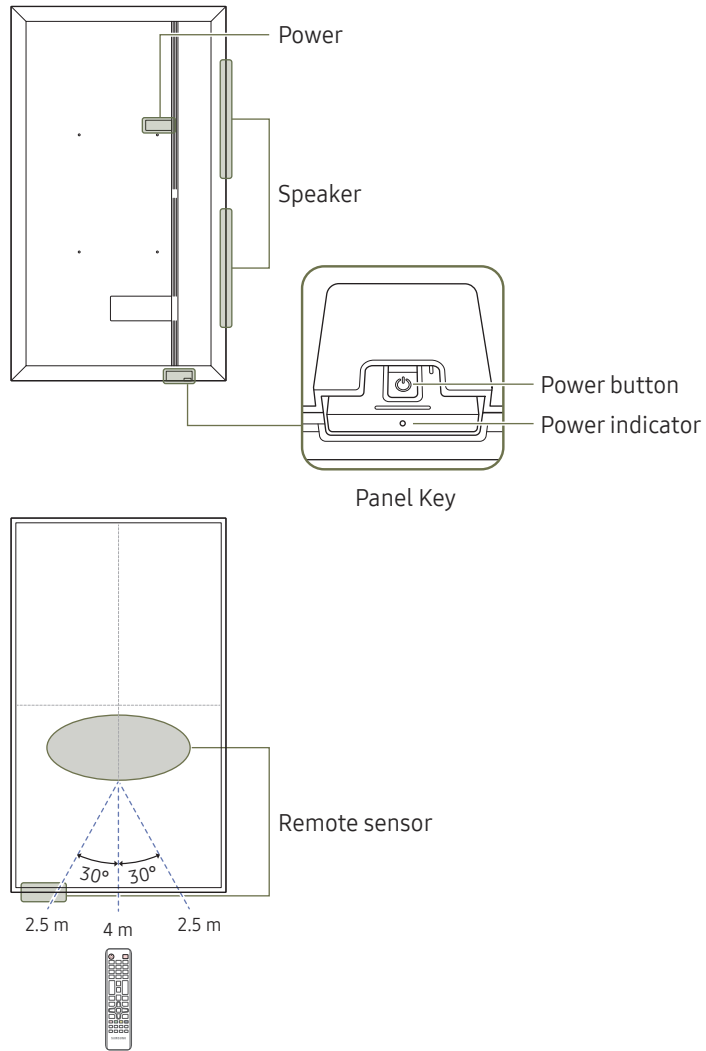

The colour and shape of parts may differ from what is shown. Specifications are subject to change without notice to improve quality.

Parts	Description
Remote sensor	Press a button on the remote control pointing at the sensor on the front of the product to perform the corresponding function. Using other display devices in the same space as the remote control of this product can cause the other display devices to be inadvertently controlled.
	Use the remote sensor while holding down the sliding panel key.
Panel Key	To use the panel key, make sure the sliding panel key is not protruding from the bottom of the product.
Power button	Turns the product on or off.

Remote sensor in the screen: Use the remote control within 2.5 m to 4 m from the sensor on the product at an angle of 30° from the left and right.

Remote sensor at the bottom: Use the remote control within 7 m to 10 m from the sensor on the product at an angle of 30° from the left and right.









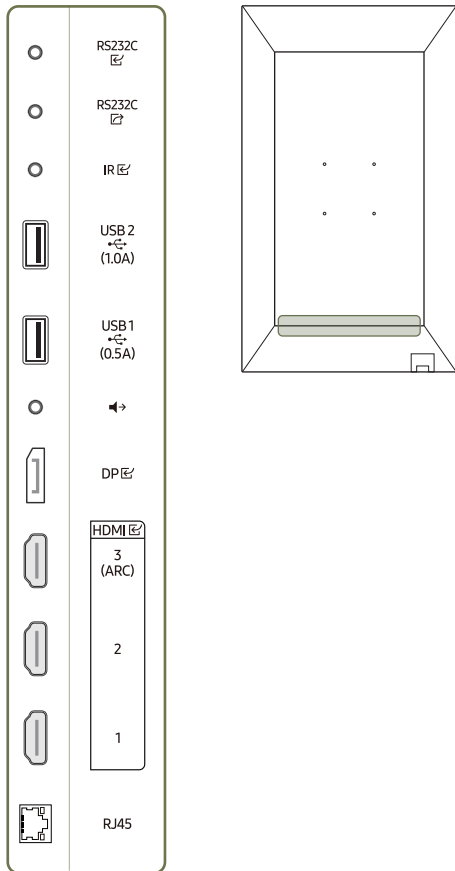



To enhance the IR receiver performance, connect an external IR cable (sold separately) to the IR IN port.

## Ports

 The colour and shape of parts may differ from what is shown. Specifications are subject to change without notice to improve quality.

### SM32HX-P



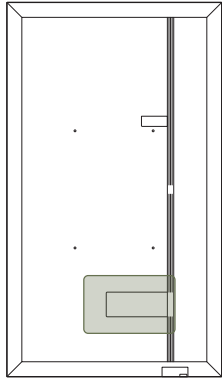
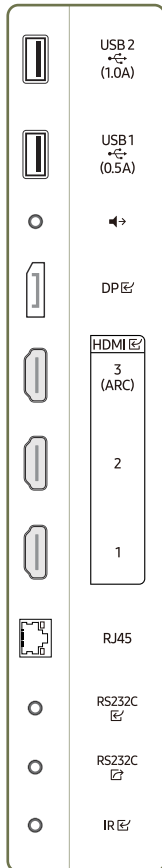

Port	Description
RS232C 	Connects to MDC using an RS232C adapter.
RS232C 	
IR 	Connects to an external IR cable that receives signals from the remote control.
USB 2  (1.0A)	Connect to a USB memory device.  The USB ports on the product accept a maximum constant current of 1.0A. If the maximum value is exceeded, USB ports may not work.
USB 1  (0.5A)	Connect to a USB memory device.  The USB ports on the product accept a maximum constant current of 0.5A. If the maximum value is exceeded, USB ports may not work.
	Outputs sound to an audio device through an audio cable.
DP 	Connects to a PC using a DP cable.
HDMI  3 (ARC)	Connects to a source device using a HDMI cable.
HDMI 	
HDMI 	
RJ45	Connects to MDC and the Internet using a LAN cable. (10/100 Mbps)  Use Cat7(*STP Type) cable for the connection. *Shielded Twisted Pair

## SM55HX-P / SM85HX-P





Port	Description
USB 2 (1.0A)	Connect to a USB memory device. ✎ The USB ports on the product accept a maximum constant current of 1.0A. If the maximum value is exceeded, USB ports may not work.
USB 1 (0.5A)	Connect to a USB memory device. ✎ The USB ports on the product accept a maximum constant current of 0.5A. If the maximum value is exceeded, USB ports may not work.
Speaker icon	Outputs sound to an audio device through an audio cable.
DP	Connects to a PC using a DP cable.
HDMI 3 (ARC)	Connects to a source device using a HDMI cable.
HDMI 2	
HDMI 1	
RJ45	Connects to MDC and the Internet using a LAN cable. (10/100 Mbps) ✎ Use Cat7(*STP Type) cable for the connection. *Shielded Twisted Pair
RS232C	Connects to MDC using an RS232C adapter.
RS232C	
IR	Connects to an external IR cable that receives signals from the remote control.

## Control menu

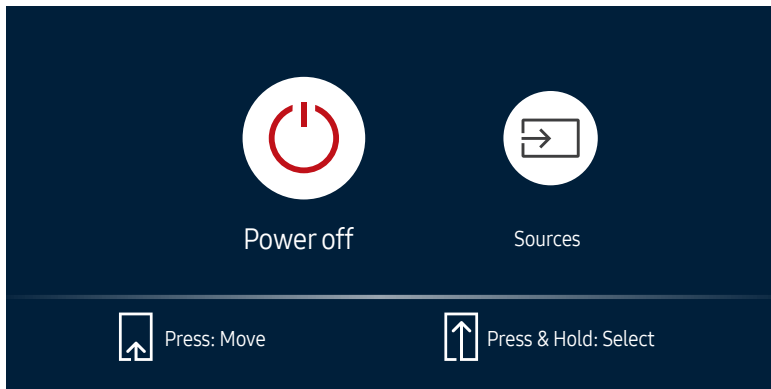
-  The power button (⏻) is located on the bottom or rear of the product, depending on the model.
-  If you press the power button on the product when the product is turned on, the control menu will be displayed.



Items	Description
 <b>Power off</b>	Power off the product. <ul style="list-style-type: none"><li>With the control menu screen displayed, briefly press the power button to move the cursor to <b>Power off</b> (⏻), and then press and hold the power button to turn off the product.</li></ul>
 <b>Sources</b>	Select the connected input source. <ul style="list-style-type: none"><li>With the control menu screen displayed, briefly press the power button to move the cursor to <b>Sources</b> (⏻), and then press and hold the power button to display the input source screen.</li><li>With the input source screen displayed, press and hold the power button to switch to the desired input source.</li></ul>

-  The power button can only be used for **Power off** and **Sources**.
-  To exit from the control menu screen, wait for 3 seconds or more without pressing the power button.

# Remote Control

- ✎ Using other display devices in the same space as the remote control of this product can cause the other display devices to be inadvertently controlled.
- ✎ A button without a description in the image below is not supported on the product.
- ✎ The FREEZE function is only available for **Sources**.

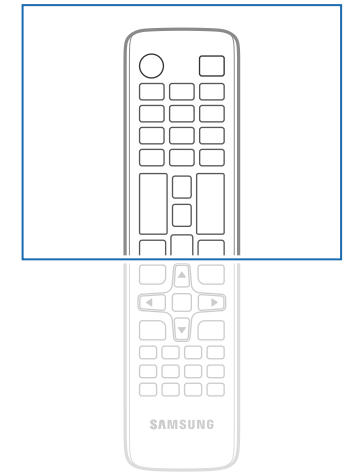
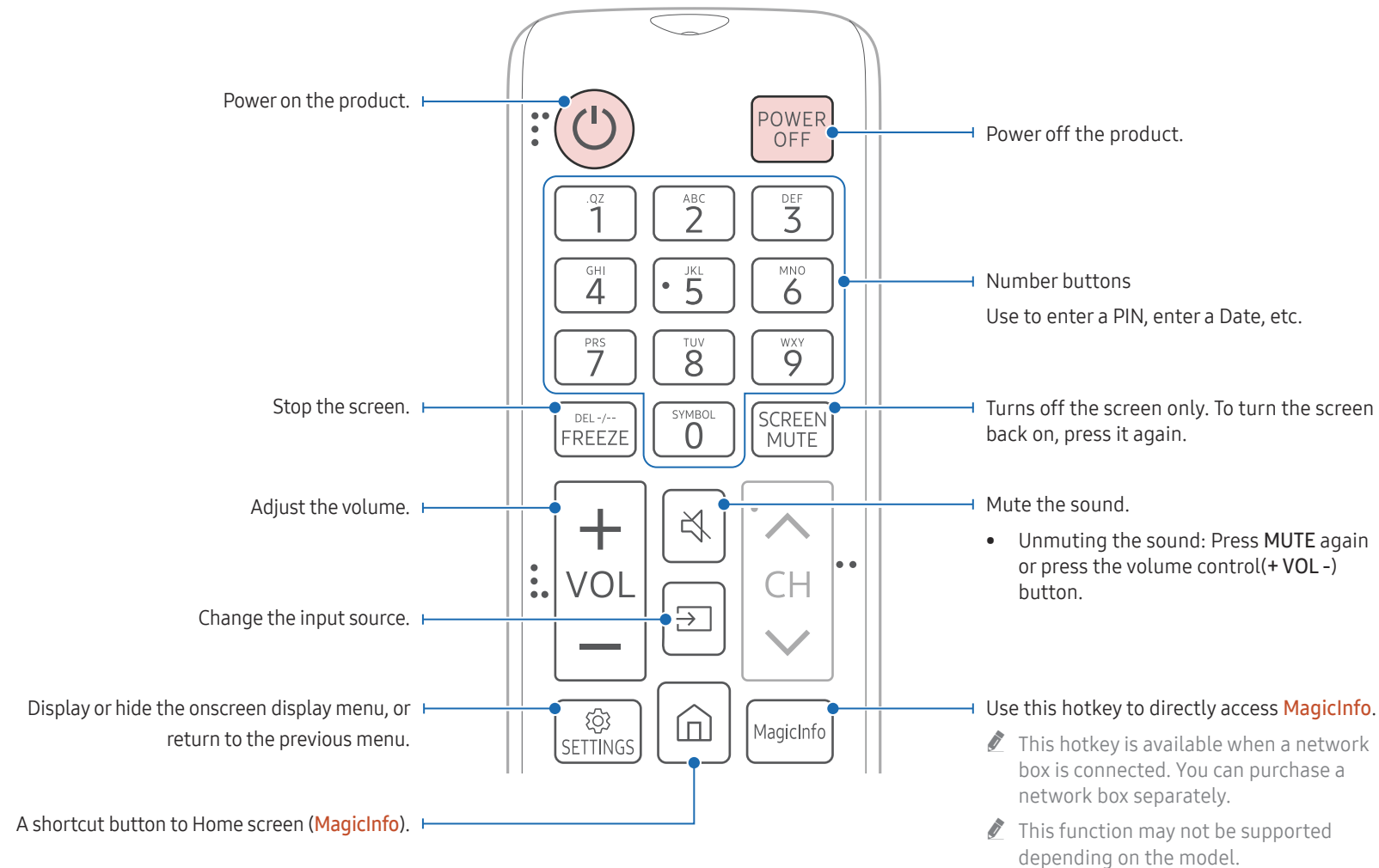

✎ Remote control button functions may differ for different products.

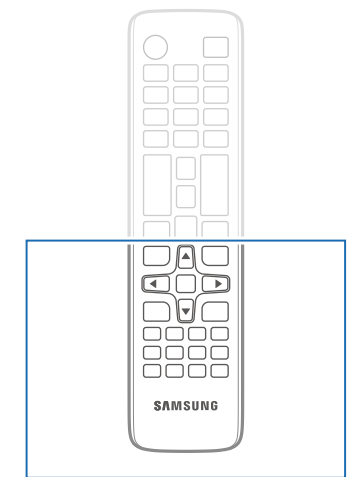
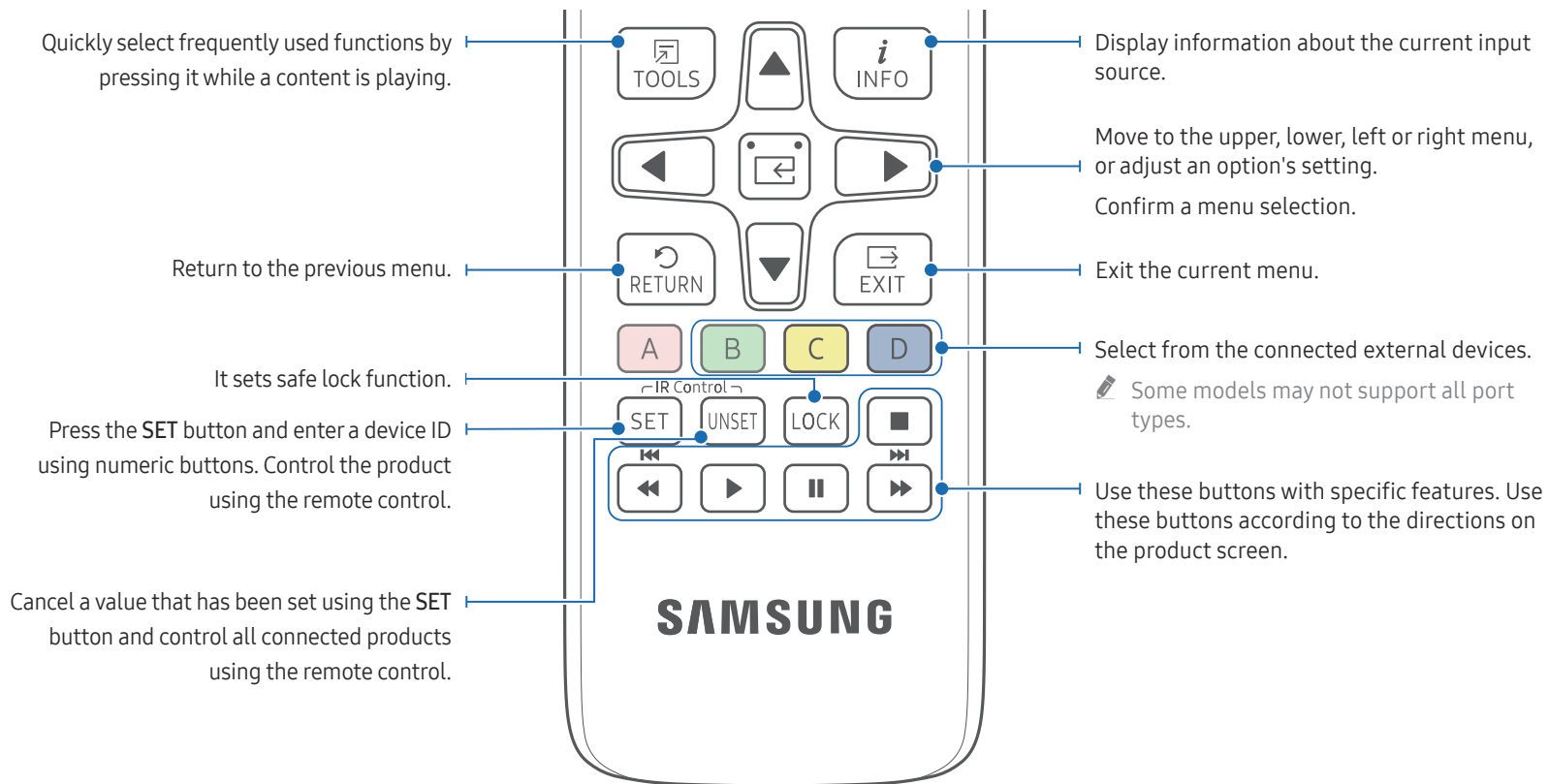

Remote control button functions may differ for different products.

## To place batteries in the remote control (AAA x 2)

Remove batteries when the remote control is not to be used for an extended period of time.

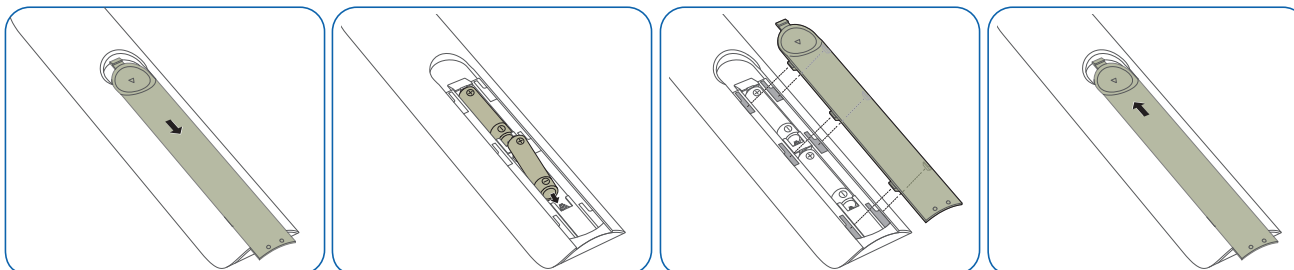

## Before Installing the Product (Installation Guide)

To prevent injury, this apparatus must be securely attached to the floor/wall in accordance with the installation instructions.

- Ensure that an authorised installation company installs the wall mount.
- Otherwise, it may fall and cause personal injury.
- Make sure to install the specified wall mount.

 Do not use this model installed on a ceiling, floor, or table.

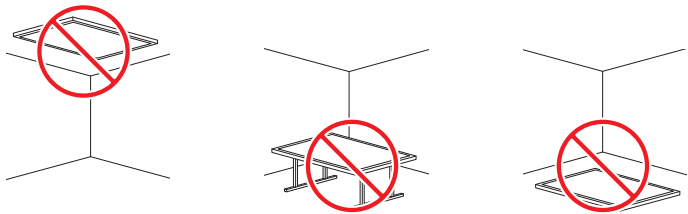

## Ventilation

 Contact Samsung Customer Service Centre for further details.

## Installation on a Perpendicular Wall

A Minimum 7.5 mm

B Ambient temperature: Under 35 °C

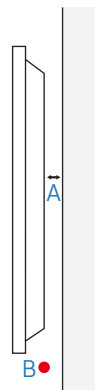

## Optimal Viewing Distance and Height

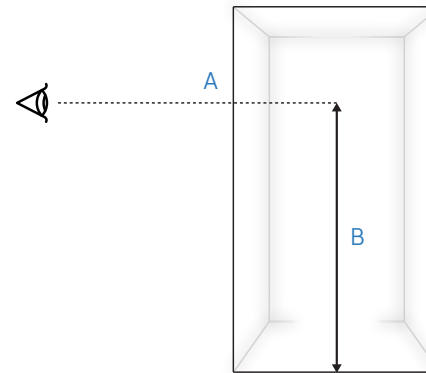

Model Name	A	B
SM32HX-P	1–2 m	0.43 m
SM55HX-P	1.5–2 m	0.81 m
SM85HX-P	2–3 m	1.3 m

## Background images for 3D effects

This product creates a 3D sense of space by printing the background image on the screen.

This background image is fixed and cannot be deleted. Depending on the viewing position, horizontal and vertical printed lines may appear as borders or patterns. This is part of the product's design and is not a defect.

 This product does not convert content to 3D content.

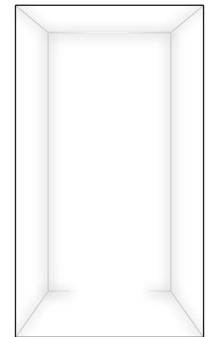

---

## Installing the Wall Mount

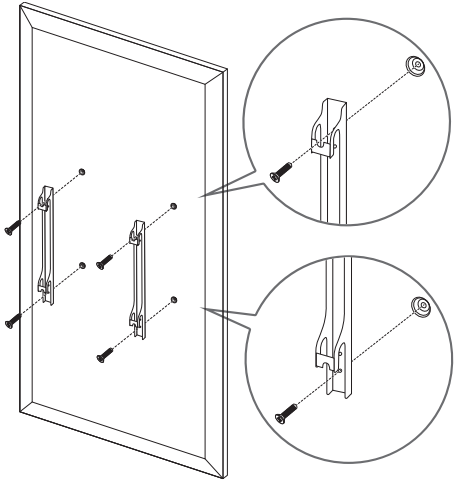

### Preparing before installing Wall-Mount

To install a wall mount not made by Samsung, refer to the installation manual provided by the wall mount manufacturer.

### Installing the Wall Mount

- The wall mount kit (sold separately) allows you to mount the product on the wall.
- The provided image is only for reference. For detailed information on installing the wall mount, see instructions provided with the wall mount.
- We recommend you contact a technician for assistance when installing the wall mount bracket.
- Samsung is not responsible for any damage to the product or injury to yourself or others if you select to install the wall mount on your own.

## Wall Mount Kit Specifications (VESA)

✎ Install your wall mount on a solid wall perpendicular to the floor. To install the product on the other wall area, contact the nearest agency. If you install the product on a slanted wall, it may fall and result in severe personal injury.

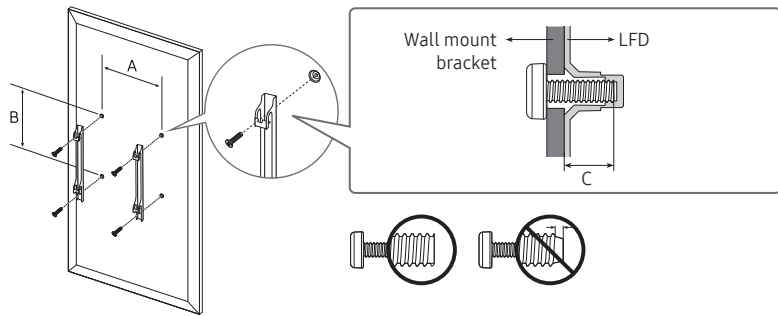

- Samsung wall mount kits contain a detailed installation manual and all parts necessary for assembly are provided.
- Do not use screws that are longer than the standard length or do not comply with the VESA standard screw specifications. Screws that are too long may cause damage to the inside of the product.
- For wall mounts that do not comply with the VESA standard screw specifications, the length of the screws may differ depending on the wall mount specifications.
- Do not fasten the screws too firmly. This may damage the product or cause the product to fall, leading to personal injury. Samsung is not liable for these kinds of accidents.
- Samsung is not liable for product damage or personal injury when a non-VESA or non-specified wall mount is used or the consumer fails to follow the product installation instructions.
- Always have at least two people mount the product on a wall. (Four or more people for the 82-inch size and larger models.)
- Standard dimensions for wall mount kits are shown in the table below.

Model Name	VESA screw hole specs (A * B) in millimetres	C(mm)	Standard Screw	Quantity
SM32HX-P	100 x 100	18 - 20	M4	4
SM55HX-P	200 x 200	19 - 21	M8	
SM85HX-P	400 x 600	18 - 20		

✎ Do not install your Wall Mount Kit while your product is turned on. It may result in personal injury due to electric shock.

# Chapter 03

## Connecting and Using a Source Device

### Before Connecting

#### Pre-connection Checkpoints

- ✎ Refer to the user guide for the source device you want to connect with.  
The number and location of ports available on the source device may vary depending on the model.
- ✎ Do not connect the power cord until all connections are completed.  
Connecting the power cord during connection may damage the product.
- ✎ Check the types of ports at the back of the product you want to connect.
- ✎ We recommend using authorised cables for HDMI cable connections.

### Connecting to a PC

- Do not connect the power cord before connecting all other cables.  
Ensure you connect a source device first before connecting the power cord.
- A PC can be connected to the product in a variety of ways.  
Select a connection method suitable for your PC.

#### Connection Using an HDMI Cable

- ✎ Connecting parts may differ in different products.

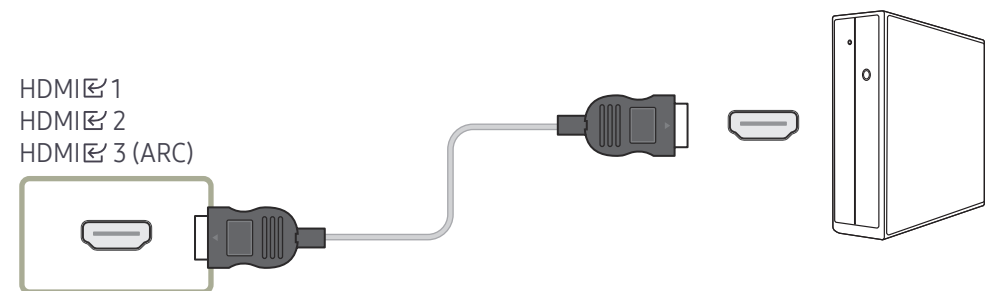



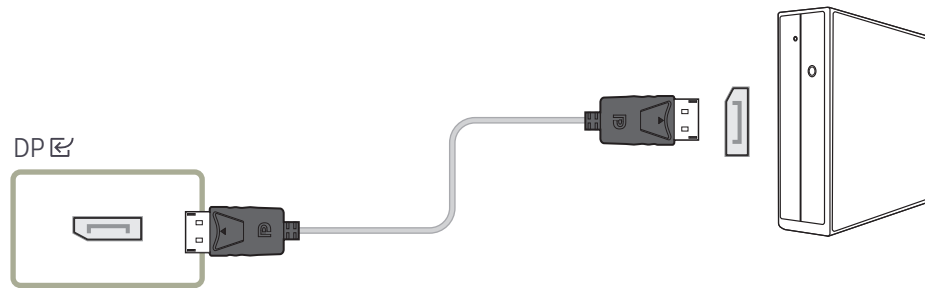

## Connection Using an DP Cable

 Connecting parts may differ in different products.



### • Precautions for using DP

-  To increase the standby power capacity, the product stops DP communication when it is turned off or in power-saving mode.
-  If the product in dual monitor mode is turned off or goes into power-saving mode, monitor setting changes may not be updated. As a result, screen output may not be displayed properly.
-  Some graphics cards that are not compliant with the DP standard may prevent the Windows Booting/Bios screen from being displayed when the product is in power-saving mode. If this is the case, make sure to turn on the product first before turning on your PC.
-  The DisplayPort interface (DP IN) on the product and the provided DP cable are designed based on the VESA standards. Using a DP cable that is not VESA compliant may cause the product to function improperly. Samsung shall not be held responsible for any issues from using a cable that is not VESA compliant. Make sure to use a DP cable that is VESA compliant.

## Connecting to a Video Device

- Do not connect the power cord before connecting all other cables. Ensure you connect a source device first before connecting the power cord.
- You can connect a video device to the product using a cable.
-  Press the SOURCE button on the remote control to change the source.

### Using an HDMI Cable

- An HDMI cable supports digital video and audio signals, and does not require an audio cable.
- The picture may not display normally (if at all) or the audio may not work if an external device that uses an older version of HDMI mode is connected to the product. If such a problem occurs, ask the manufacturer of the external device about the HDMI version and, if out of date, request an upgrade.
- Be sure to use an HDMI cable with a thickness of 14 mm or less.
- Be sure to purchase a certified HDMI cable. Otherwise, the picture may not display or a connection error may occur.
- A basic high-speed HDMI cable or one with ethernet is recommended. This product does not support the ethernet function through HDMI.

## Connection Using an HDMI Cable

 Connecting parts may differ in different products.

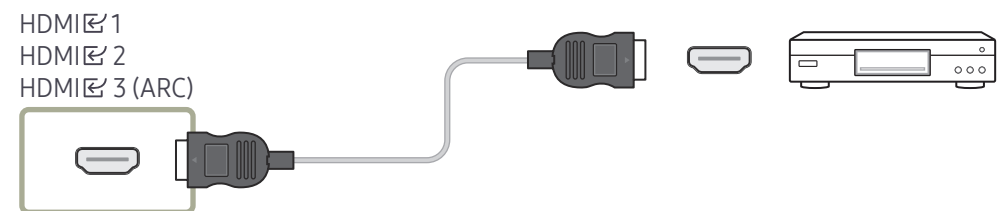

## Connecting HDMI to Sound system and Video device

 Connecting parts may differ in different products.

After connecting a video device to the product using SOUND BAR HDMI Port an HDMI cable, make sure to configure the settings as shown below.

**Settings** → **System** → **General** → set **HDMI Hot Plug** to **Off**

HDMI 3 (ARC)

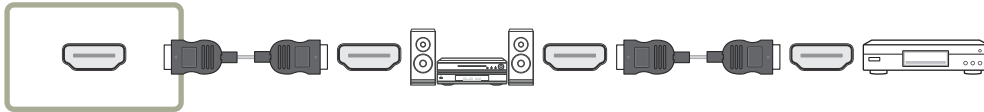

## Connecting the LAN Cable

 Connecting parts may differ in different products.

RJ45



- Use Cat7(\*STP Type) cable for the connection. (10/100 Mbps)  
\*Shielded Twisted Pair

## Connecting to an Audio system

 Connecting parts may differ in different products.

 Make sure to connect the same colour connectors together. (white to white, red to red, etc.)

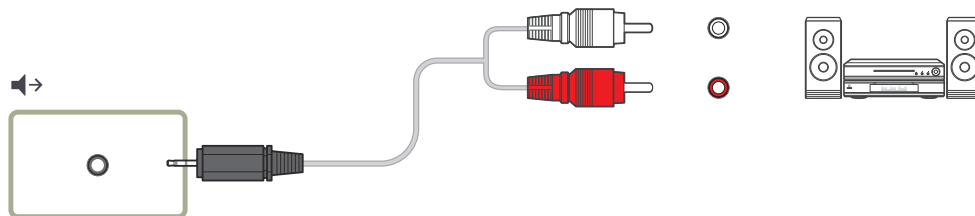

# Changing the Input source

## Sources

→ Sources

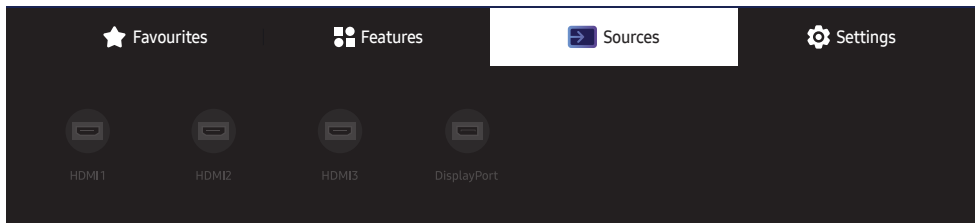

The displayed image may differ depending on the model.

**Sources** allow you to select a variety of sources and change source device names.

You can display the screen of a source device connected to the product. Select a source from source list to display the screen of the selected source.

- The input source can also be changed by using the SOURCE button on the remote control.
- The screen may not display correctly if an incorrect source is selected for the source device you want to convert to.

## Edit

→ Sources → Edit →

Edit the name and device type of a connected external device.

- The list can include the following source devices. Source devices on the list differ depending on the selected source.  
**HDMI 1 / HDMI 2 / HDMI 3 / DisplayPort / Cable Box / Game Console / PC / Blu-ray player / Home Theatre System**
- Available source devices may vary depending on the product.

# Chapter 04

## Multiple Display Control

Control multiple display devices connected to a PC simultaneously.

### Cable Connection

#### RS232C Cable

Interface	RS232C (9 pins)
Pin	TxD (No.2), RxD (No.3), GND (No.5)
Bit rate	9600 bps
Data bits	8 bit
Parity	None
Stop bit	1 bit
Flow control	None
Maximum length	15 m (only shielded type)

- Pin assignment

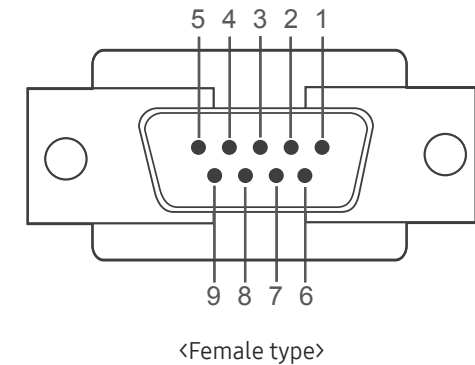
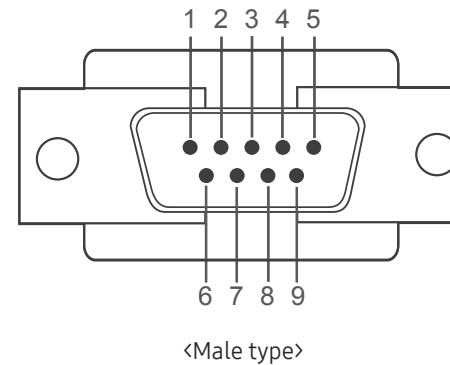

Pin	Signal
1	Detect data carrier
2	Received data
3	Transmitted data
4	Prepare data terminal
5	Signal ground

Pin	Signal
6	Prepare data set
7	Send request
8	Clear to send
9	Ring indicator

- RS232C cable  
Connector: 9-Pin D-Sub to Stereo Cable

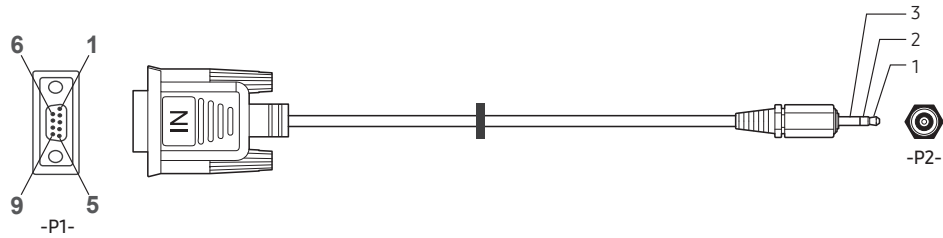

	-P1-		-P1-		-P2-	
	Rx	2	↔	1	Tx	STEREO
Male type	Tx	3	↔	2	Rx	PLUG
	Gnd	5	↔	3	Gnd	(3.5ø)

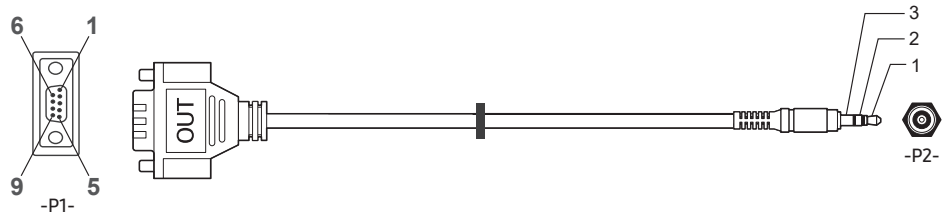

	-P1-		-P1-		-P2-	
	Rx	3	↔	1	Tx	STEREO
Female type	Tx	2	↔	2	Rx	PLUG
	Gnd	5	↔	3	Gnd	(3.5ø)

This function may differ depending on the model.

## LAN Cable

- Pin assignment

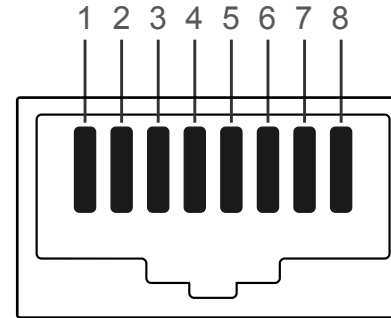

Pin No	Standard Colour	Signal
1	White and orange	TX+
2	Orange	TX-
3	White and green	RX+
4	Blue	NC
5	White and blue	NC
6	Green	RX-
7	White and brown	NC
8	Brown	NC

- Connector : RJ45

### Direct LAN cable (PC to HUB)

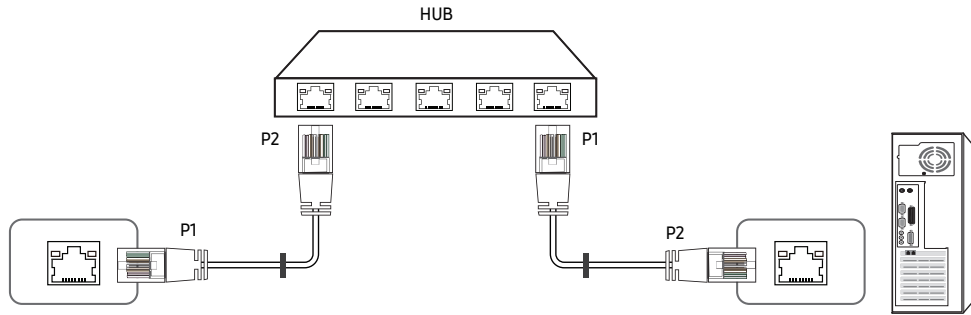

Signal	P1		P2	Signal
TX+	1	↔	1	TX+
TX-	2	↔	2	TX-
RX+	3	↔	3	RX+
RX-	6	↔	6	RX-

### Cross LAN cable (PC to LFD)

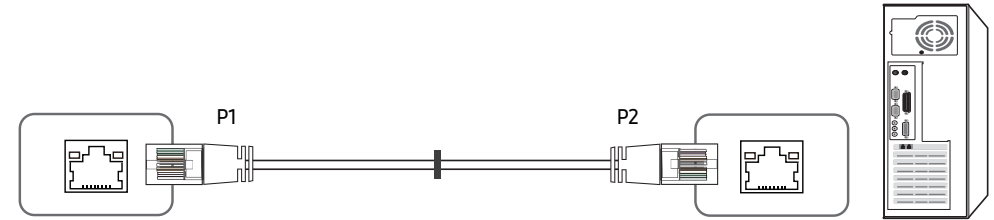

Signal	P1		P2	Signal
TX+	1	↔	3	RX+
TX-	2	↔	6	RX-
RX+	3	↔	1	TX+
RX-	6	↔	2	TX-

# Connection

- ✎ Ensure you connect each of the adapters to the correct RS232C port on the product.
- ✎ Connecting parts may differ depending on the model.

- Connection 1

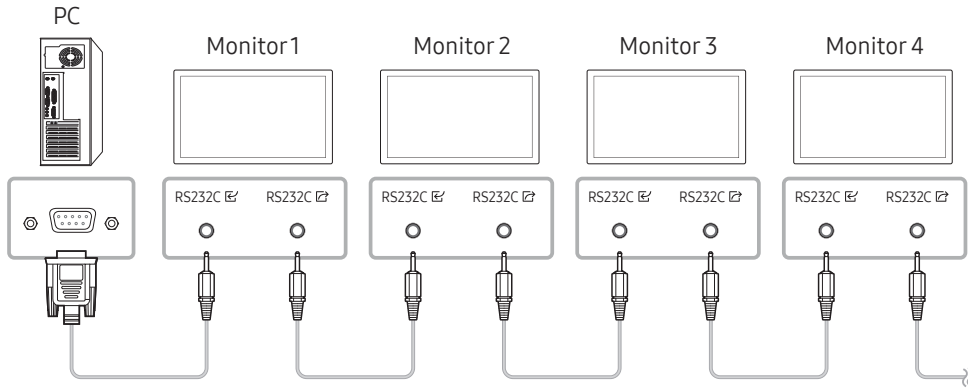

- Connection 2

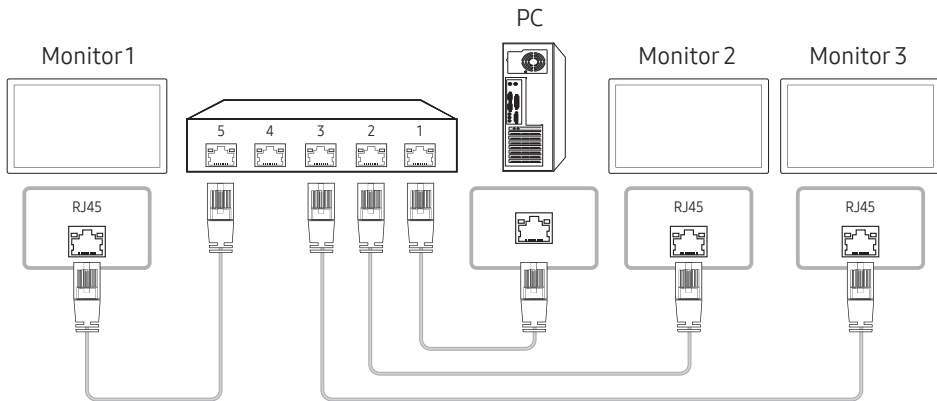

- Connection 3

- ✎ This option is only available for models that have RJ45 ports.

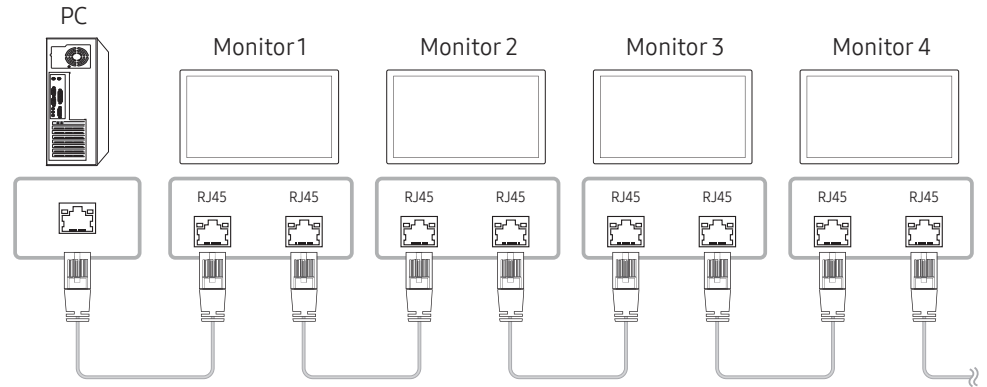

## Control Codes

### Viewing control state (Get control command)

Header	Command	ID	Data length	Checksum
0xAA	Command type		0	

### Controlling (Set control command)

Header	Command	ID	Data length	Data	Checksum
0xAA	Command type		1	Value	

### Command

No.	Command type	Command	Value range
1	Power control	0x11	0~1
2	Volume control	0x12	0~100
3	Input source control	0x14	-
4	Screen size control	0x19	0~255
5	Video wall mode control	0x5C	0~1
6	Safety Lock	0x5D	0~1
7	Video Wall On	0x84	0~1
8	Video Wall User Control	0x89	-

- All communications take place in hexadecimals. The checksum is calculated by adding up all values except the header. If a checksum adds up to be more than 2 digits as shown below (11+FF+01+01=112), the first digit is removed.

E.g. Power On & ID=0

Header	Command	ID	Data length	Data 1	Checksum
0xAA	0x11		1	"Power"	

Header	Command	ID	Data length	Data 1	12
0xAA	0x11		1	1	

- To control all devices connected by a serial cable simultaneously irrespective of IDs, set the ID as "0xFE" and transmit commands. Commands will be executed by each device but ACK will not respond.

## Power control

- Function  
A product can be powered on and off using a PC.
- Viewing power state (Get Power ON / OFF Status)

Header	Command	ID	Data length	Checksum
0xAA	0x11		0	

- Setting power ON/Off (Set Power ON / OFF)

Header	Command	ID	Data length	Data	Checksum
0xAA	0x11		1	"Power"	

"Power": Power code to be set on a product.

1: Power ON

0: Power OFF

- Ack

Header	Command	ID	Data length	Ack/Nak	r-CMD	Val1	Checksum
0xAA	0xFF		3	'A'	0x11	"Power"	

"Power": Power code to be set on a product.

- Nak

Header	Command	ID	Data length	Ack/Nak	r-CMD	Val1	Checksum
0xAA	0xFF		3	'N'	0x11	"ERR"	

"ERR" : A code showing what error has occurred.

## Volume control

- Function  
The volume of a product can be adjusted using a PC.
- Viewing volume state (Get Volume Status)

Header	Command	ID	Data length	Checksum
0xAA	0x12		0	

- Setting the volume (Set Volume)

Header	Command	ID	Data length	Data	Checksum
0xAA	0x12		1	"Volume"	

"Volume": Volume value code to be set on a product. (0-100)

- Ack

Header	Command	ID	Data length	Ack/Nak	r-CMD	Val1	Checksum
0xAA	0xFF		3	'A'	0x12	"Volume"	

"Volume": Volume value code to be set on a product. (0-100)

- Nak

Header	Command	ID	Data length	Ack/Nak	r-CMD	Val1	Checksum
0xAA	0xFF		3	'N'	0x12	"ERR"	

"ERR" : A code showing what error has occurred.

## Input source control

- **Function**  
The input source of a product can be changed using a PC.
- **Viewing input source state (Get Input Source Status)**

Header	Command	ID	Data length	Checksum
0xAA	0x14		0	

- **Setting the input source (Set Input Source)**

Header	Command	ID	Data length	Data	Checksum
0xAA	0x14		1	"Input Source"	

"Input Source": An input source code to be set on a product.

0x0C	Input source
0x20	MagicInfo
0x21	HDMI1
0x22	HDMI1_PC
0x23	HDMI2
0x24	HDMI2_PC
0x25	DisplayPort

 HDMI1\_PC and HDMI2\_PC cannot be used with the Set command. They only respond to "Get" commands.

 **MagicInfo** is only available with models that contain the **MagicInfo** function.

- **Ack**

Header	Command	ID	Data length	Ack/Nak	r-CMD	Val1	Checksum
0xAA	0xFF		3	'A'	0x14	"Input Source"	

"Input Source": An input source code to be set on a product.

- **Nak**

Header	Command	ID	Data length	Ack/Nak	r-CMD	Val1	Checksum
0xAA	0xFF		3	'N'	0x14	"ERR"	

"ERR" : A code showing what error has occurred.

## Screen size control

- Function  
The screen size of a product can be changed using a PC.
- Viewing the screen size (Get Screen Size Status)

Header	Command	ID	Data length	Checksum
0xAA	0x19		0	

- Ack

Header	Command	ID	Data length	Ack/Nak	r-CMD	Val1	Checksum
0xAA	0xFF		3	'A'	0x19	"Screen Size"	

"Screen Size": product screen size (range: 0 – 255, unit: inch)

- Nak

Header	Command	ID	Data length	Ack/Nak	r-CMD	Val1	Checksum
0xAA	0xFF		3	'N'	0x19	"ERR"	

"ERR": A code showing what error has occurred

## Video Wall Mode Control

- Function  
**Video Wall** mode can be activated on a product using a PC.  
This control is only available on a product whose **Video Wall** is enabled.
- Viewing video wall mode (Get Video Wall Mode)

Header	Command	ID	Data length	Checksum
0xAA	0x5C		0	

- Setting the video wall (Set Video Wall Mode)

Header	Command	ID	Data length	Data	Checksum
0xAA	0x5C		1	"Video Wall Mode"	

"Video Wall Mode": A code used to activate Video Wall mode on a product

1: Full

0: Natural

- Ack

Header	Command	ID	Data length	Ack/Nak	r-CMD	Val1	Checksum
0xAA	0xFF		3	'A'	0x5C	"Video Wall Mode"	

"Video Wall Mode": A code used to activate Video Wall mode on a product

- Nak

Header	Command	ID	Data length	Ack/Nak	r-CMD	Val1	Checksum
0xAA	0xFF		3	'A'	0x5C	"ERR"	

"ERR": A code showing what error has occurred

## Safety Lock

- Function  
PC can be used to turn the **Safety Lock On** function on or off on a product.  
This control is available regardless of whether or not the power is turned on.
- Viewing the safety lock state (Get Safety Lock Status)

Header	Command	ID	Data length	Checksum
0xAA	0x5D		0	

- Enabling or disabling safety lock (Set Safety Lock Enable / Disable)

Header	Command	ID	Data length	Data	Checksum
0xAA	0x5D		1	"Safety Lock"	

"Safety Lock": Safety lock code to be set on a product

1: ON

0: OFF

- Ack

Header	Command	ID	Data length	Ack/Nak	r-CMD	Val1	Checksum
0xAA	0xFF		3	'A'	0x5D	"Safety Lock"	

"Safety Lock": Safety lock code to be set on a product

- Nak

Header	Command	ID	Data length	Ack/Nak	r-CMD	Val1	Checksum
0xAA	0xFF		3	'N'	0x5D	"ERR"	

"ERR": A code showing what error has occurred

## Video Wall On

- Function  
Turn Video Wall on or off on the product from your computer.  
This control is only available on a product whose **Video Wall** is enabled.
- Get Video Wall On/Off Status

Header	Command	ID	Data length	Checksum
0xAA	0x84		0	

- Set Video Wall On/Off

Header	Command	ID	Data length	Data	Checksum
0xAA	0x84		1	V.Wall_On	

- V.Wall\_On: Video Wall code to be assigned to the product

1: Video Wall ON

0: Video Wall OFF

- Ack

Header	Command	ID	Data length	Ack/Nak	r-CMD	Val1	Checksum
0xAA	0xFF		3	'A'	0x84	V.Wall_On	

V.Wall\_On : Same as above

- Nak

Header	Command	ID	Data length	Ack/Nak	r-CMD	Val1	Checksum
0xAA	0xFF		3	'N'	0x84	ERR	

"ERR": A code showing what error has occurred

## Video Wall User Control

- **Function**  
Turn the Video Wall function on or off on the product from your computer.  
This control is only available on a product whose **Video Wall** is enabled.
- **Get Video Wall Status**

Header	Command	ID	Data length	Checksum
0xAA	0x89		0	

- **Set Video Wall**

Header	Command	ID	Data length	Val1	Val2	Checksum
0xAA	0x89		2	Wall_Div	Wall_SNo	

Wall\_SNo: Product Number code assigned to the product

10x10 Video Wall Model : (1 ~ 100)	
Set Number	Data
1	0x01
2	0x02
...	...
99	0x63
100	0x64

- **Ack**

Header	Command	ID	Data length	Ack/Nak	r-CMD	Val1	Val2	Checksum
0xAA	0xFF		4	'A'	0x89	Wall_Div	Wall_SNo	

- **Nak**

Header	Command	ID	Data length	Ack/Nak	r-CMD	Val1	Checksum
0xAA	0xFF		3	'N'	0x89	ERR	

"ERR": A code showing what error has occurred

Wall\_Div: Video Wall Divider code assigned to the product



10x10 Video Wall Model															
	1	2	3	4	5	6	7	8	9	10	11	12	13	14	15
Off	0x00	0x00	0x00	0x00	0x00	0x00	0x00	0x00	0x00	0x00	0x00	0x00	0x00	0x00	0x00
1	0x11	0x12	0x13	0x14	0x15	0x16	0x17	0x18	0x19	0x1A	0x1B	0x1C	0x1D	0x1E	0x1F
2	0x21	0x22	0x23	0x24	0x25	0x26	0x27	0x28	0x29	0x2A	0x2B	0x2C	0x2D	0x2E	0x2F
3	0x31	0x32	0x33	0x34	0x35	0x36	0x37	0x38	0x39	0x3A	0x3B	0x3C	0x3D	0x3E	0x3F
4	0x41	0x42	0x43	0x44	0x45	0x46	0x47	0x48	0x49	0x4A	0x4B	0x4C	0x4D	0x4E	0x4F
5	0x51	0x52	0x53	0x54	0x55	0x56	0x57	0x58	0x59	0x5A	0x5B	0x5C	0x5D	0x5E	0x5F
6	0x61	0x62	0x63	0x64	0x65	0x66	0x67	0x68	0x69	0x6A	0x6B	0x6C	0x6D	0x6E	0x6F
7	0x71	0x72	0x73	0x74	0x75	0x76	0x77	0x78	0x79	0x7A	0x7B	0x7C	0x7D	0x7E	N/A
8	0x81	0x82	0x83	0x84	0x85	0x86	0x87	0x88	0x89	0x8A	0x8B	0x8C	N/A	N/A	N/A
9	0x91	0x92	0x93	0x94	0x95	0x96	0x97	0x98	0x99	0x9A	0x9B	N/A	N/A	N/A	N/A
10	0xA1	0xA2	0xA3	0xA4	0xA5	0xA6	0xA7	0xA8	0xA9	0xAA	N/A	N/A	N/A	N/A	N/A
11	0xB1	0xB2	0xB3	0xB4	0xB5	0xB6	0xB7	0xB8	0xB9	N/A	N/A	N/A	N/A	N/A	N/A
12	0xC1	0xC2	0xC3	0xC4	0xC5	0xC6	0xC7	0xC8	N/A	N/A	N/A	N/A	N/A	N/A	N/A
13	0xD1	0xD2	0xD3	0xD4	0xD5	0xD6	0xD7	N/A	N/A	N/A	N/A	N/A	N/A	N/A	N/A
14	0xE1	0xE2	0xE3	0xE4	0xE5	0xE6	0xE7	N/A	N/A	N/A	N/A	N/A	N/A	N/A	N/A
15	0xF1	0xF2	0xF3	0xF4	0xF5	0xF6	N/A	N/A	N/A	N/A	N/A	N/A	N/A	N/A	N/A

---

## Using MDC

Multiple display control "MDC" is an application that allows you to easily control multiple display devices simultaneously using a PC.



For details on how to use the MDC programme, refer to Help after installing the programme. The MDC programme is available on the website. (<http://www.samsung.com/business>)



-  If you press the **On** or **Off** button located at the top left of the screen, the product checks its status for about one minute. To run other commands, try after the one minute.
-  For details on how to connect devices for multiple display control, refer to page [29](#).

## MDC Programme Installation/Uninstallation

-  Installing and uninstalling steps can vary depending on the OS.

### Installation

-  MDC installation can be affected by the graphics card, mother board and network conditions.
- 1 Click the **MDC Unified** installation programme.
  - 2 Click "**Next**".
  - 3 When the "**Welcome to the InstallShield Wizard for MDC\_Unified**" screen appears, click "**Next**".
  - 4 In the "**License Agreement**" window displayed, select "**I accept the terms in the license agreement**" and click "**Next**".
  - 5 In the displayed "**Customer Information**" window, fill out all the information fields and click "**Next**".
  - 6 In the displayed "**Destination Folder**" window, select the directory path you want to install the programme in and click "**Next**".
    -  If the directory path is not specified, the programme will be installed in the default directory path.

- 7 In the displayed "**Ready to Install the Program**" window, check the directory path to install the programme in and click "**Install**".
- 8 Installation progress will be displayed.
- 9 Click "**Finish**" in the displayed "**InstallShield Wizard Complete**" window.
  -  Select "**Launch the program**" and click "**Finish**" to run the MDC programme immediately.
- 10 The **MDC Unified** shortcut icon will be created on the desktop after installation.
  -  The MDC execution icon may not be displayed depending on the PC system or product specifications.
  -  Press F5 if the execution icon is not displayed.

### Uninstallation

- 1 Select **Settings** → **Control Panel** on the **Start** menu and double-click **Add/Delete Program**.
- 2 Select **MDC Unified** from the list and click **Change/Remove**.

# Chapter 05

## Home Screen

Accessible using the  button on the remote control.

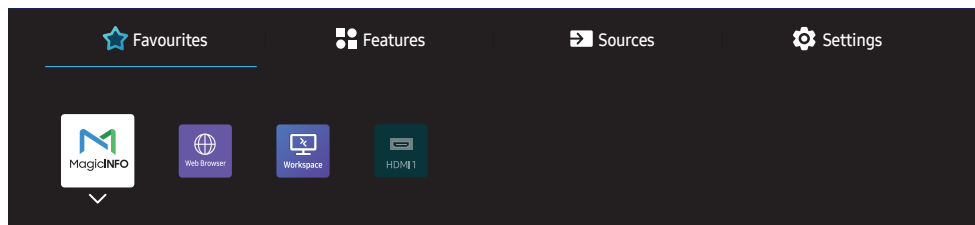

### Favourites

 → Favourites



 The displayed image may differ depending on the model.

Add features available under **Sources** or **Features** that are frequently used, to **Favourites**.

 Press **▼** to select **Add to Favourites**, and press .

Delete or rearrange items in **Favourites**.

 Press **▼** to select **Move** or **Remove**, and press . If **Move** is selected, you can move an item to the left or right.

# Features

🏠 → Features

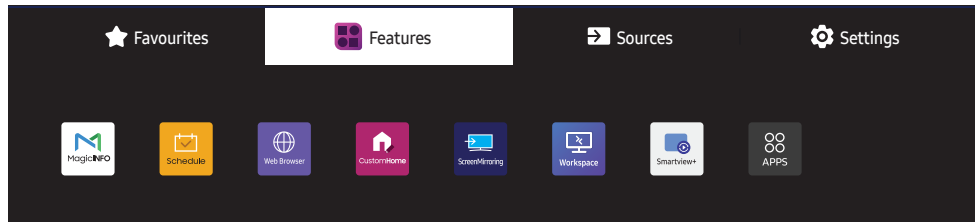

🔧 The displayed image may differ depending on the model.

Various features are available.

Add frequently used features to **Favourites**.

🔧 Press ▼ to select **Add to Favourites**, and press ↵.

You can also set options for each app.

# MagicInfo

Home → Features → MagicInfo →

Play a range of content such as channels with schedules assigned, templates or files.

This function may not be supported depending on the model.

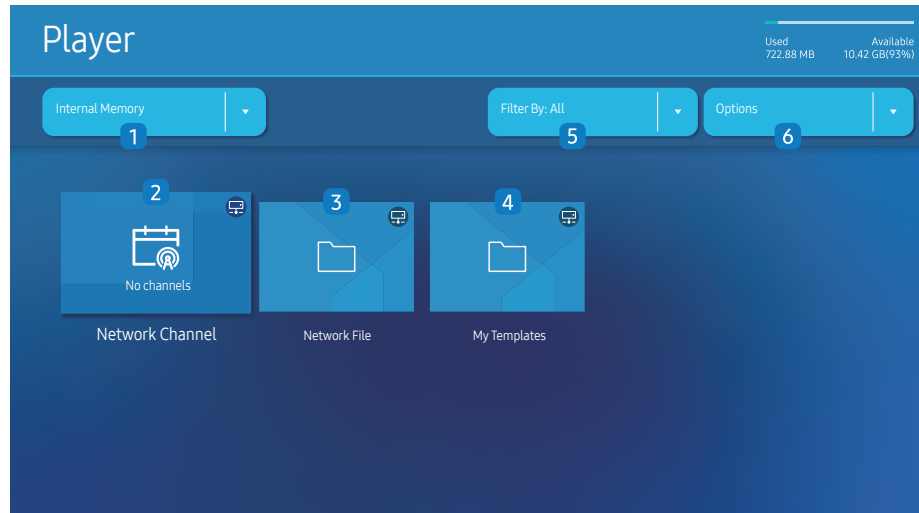

The displayed image may differ depending on the model.

You must set **Clock Set** before you can use this feature.

No.	Description
1	Select between internal or external memory.
2	Play content, templates and schedules configured on the server. <ul style="list-style-type: none"> <li>You can view whether the server is connected (approval) in the <b>Player</b> screen. To view whether the server is connected when a Network Channel is running, press <b>INFO</b> on the remote control.</li> </ul> <ol style="list-style-type: none"> <li>Select <b>Network Channel</b> from the <b>Player</b> screen. The <b>No channels</b> message appears if no channel has been registered in <b>Network Channel</b>.</li> <li><b>Network Channel</b> will run.</li> </ol>
3	Play content stored on the server.
4	Play templates stored in <b>My Templates</b> folder in the Internal Memory.  This function may not be supported depending on the model.
5	Select a content type as criterion to search for a desired content list.
6	Set different options for <b>Player</b> .

## Viewing content

- Select either internal or external memory. The files saved in the selected memory appear.
- Select the desired file. The content appears on the screen. (For more information on compatible file formats, see the "File formats compatible with Player" section.)

## When content is running

### Control buttons on the remote control

You can play, pause, or skip the content on the playlist by pressing buttons on the remote control.

Button	Function
TOOLS	Brings up the menu bar.
INFO	Displays the general information of the content.
▶	Goes to next file or page.
◀	Goes to previous file or page.
⏪ / ▶ / ⏩	Plays or pauses slide show or video content.
■	Stops displaying content and goes to the <b>Player</b> screen.
◀◀	Rewinds the video content.
▶▶	Fast forwards the video content.

- ✎ If there is only one image file in the Internal Memory or USB, the Slide Show will not play.
- ✎ If the name of a folder is too long on the USB, you cannot select the folder.
- ✎ **Portrait** option for **Content Orientation** is not available for contents with a resolution higher than 3840 x 2160.
- ✎ **Content Size** for videos with a resolution higher than 3840 x 2160 supports **Full Screen** only.

## Available menu

Press the TOOLS button on the remote control during content playback to configure settings.

Menu	Description
<b>Playlist</b>	View a list of content items currently playing.
<b>Web Element Zoom</b>	50 / 100 / 200 / 300
<b>Sound Mode</b>	Customises the audio settings for the content currently playing.
<b>Repeat All / Repeat One</b>	Set the repeat mode.
<b>Background Music</b>	Set the background music to be played when content is running.
<b>Subtitles</b>	Set up Subtitles.
<b>Reset</b>	Reset the background music.
<b>Pause</b>	Pause the background music.
<b>Prev</b>	Play the previous background music on the list.
<b>Next</b>	Play the next background music on the list.

- ✎ **Reset, Pause, Prev, Next** only appear when the background music is set.
- ✎ This function may not be supported depending on the model.

---

## File Formats Compatible with Player

- Supported file systems include FAT32 and NTFS.
- A file with a vertical and horizontal resolution larger than the maximum resolution cannot be played. Check the vertical and horizontal resolution of the file.
- Check the supported video and audio Codec types and Versions.
- Check the supported file versions.
  - ✎ PowerPoint version up to 97 – 2013 is supported
- ✎ For USB-**Internal Memory** file transfer, click **Options** → **Send**. Wait for about a 50 seconds before **OK** message appears.
  - Location of template files
    - **Internal Memory** → USB transfer: USB → under MagicinfoSlide folder
    - USB → **Internal Memory** transfer: **Internal Memory** → under My Templates folder
  - Location of other files (non-template)
    - **Internal Memory** → USB transfer: USB → under MagicinfoSlide folder
    - USB → **Internal Memory** transfer: Under the root folder
- ✎ This function may not be supported depending on the model.

## Network Schedule Multiframe

### Playback restrictions



- 1 to 3 FHD video files can be played simultaneously or only one UHD video file and one FHD video file at a time. In portrait playback mode, 3 FHD video files can be played simultaneously or only one UHD video file at a time.
- For **Office** files (PPT and Word files) and **PDF** files, only one file type is supported at a time.
- LFD(\*.LFD) files are not supported.
- Contents with a resolution higher than 3840 x 2160 are not supported.

### Sound output restrictions

- More than one sound output cannot be used.
- Playback priority: network BGM → local BGM → video file in the main frame selected by the user
  - ✎ Network BGM: Settings can be configured when creating a server schedule.
  - ✎ Local BGM: BGM settings can be configured using the tools displayed after the **TOOLS** button is pressed during **Player** playback.
  - ✎ User-selected main frame: Main frame settings can be configured when creating a server schedule.

## Template files(\*.LFD)

### Restrictions

- Check that you have **Contents** and **Schedules** folders published to the USB storage device.
  - ✎ A properly published content appears as Published Content  in the USB device.
  - ✎ When copying a content you published to a USB device (Published Content ) to the **Internal Memory**, the content appears in **Internal Memory** as Published Content  only. Contents and Schedules folders are not visible under **Internal Memory**.

### Playback restrictions

- A maximum of two video (**Video**) files can be played.
- For **Office** files (PPT and Word files) and **PDF** files, only one file type is supported at a time.
- When playing more than one video files simultaneously, make sure that the display areas are not overlapping one another.

### Sound output restrictions

- More than one sound output cannot be used.
- Playback priority: network BGM → local BGM → video file in the main frame selected by the user

Supported video codecs

File format	Container	Video codecs	Resolution	Frame rate (fps)	Bit rate (Mbps)	Audio codecs
*.avi	AVI MKV ASF MP4 3GP MOV FLV VRO VOB PS TS	H.264 BP/MP/HP	3840 x 2160	60	80	Dolby Digital LPCM ADPCM(IMA, MS) AAC HE-AAC WMA Dolby Digital+ MPEG(MP3) MPEG-H AC-4 OPUS G.711(A-Law, $\mu$ -Law)
*.mkv			1920 x 1080	120		
*.asf		HEVC (H.265 - Main)	3840 x 2160		30	
*.wmv		Motion JPEG				
*.mp4		MPEG-4 SP/ASP	1920 x 1080	120	70	
*.mov		Windows Media Video 9 (VC-1)				
*.3gp		MPEG-2				
*.vro		MPEG-1				
*.mpg		Microsoft MPEG-4 version 1/2/3				
*.mpeg		Windows Media Video 7 (WMV1) / Video 8 (WMV2)	30	20		
*.ts		H.263 Sorenson				
*.tp		VP6				
*.trp		AV1	3840 x 2160	120	80	
*.flv		WebM	VP9 (Profile 0/2)	60		
*.vob			VP8	1920 x 1080	60	
*.svi	AV1		3840 x 2160	120	80	
*.m2ts						
*.mts						
*.webm					Vorbis	
*.rmvb	RMVB	RV8/9/10 (RV30/40)	1920 x 1080	60	70	RealAudio 6

---

### Other restrictions

- Codecs may not function properly if there is a problem with the content.
- Video content does not play or does not play correctly if there is an error in the content or container.
- Sound or video may not work if they have standard bit rates/frame rates above the TV's compatibility ratings.
- If the Index Table is has an error, the Seek (Jump) function will not work.
- When playing video over a network connection, the video may not play smoothly because of data transmission speeds.
- Some USB/digital camera devices may not be compatible with the TV.
- HEVC codec is only available in MKV / MP4 / TS containers.
- The MVC codec is supported partly.

### Video decoders

- H.264 UHD is supported up to Level 5.1, and H.264 FHD is supported up to Level 4.2 (TV does not support FMO / ASO / RS).
- HEVC UHD is supported up to Level 5.2, and HEVC FHD is supported up to Level 4.1.
- HEVC 8K is supported up to Level 6.1.
- VC1 AP L4 is not supported.
- GMC 2 or above is not supported.
- When a single video file is playing, Seamless mode is not supported under the following conditions:
  - Incompatible codec (MVC, VP3, MJPEG) ↔ Incompatible codec
  - Incompatible codec ↔ Compatible codec
  - The resolution is different from that of the monitor
  - The frequency is different from that of the monitor

### Audio decoders

- WMA is supported up to 10 Pro 5.1 channels, M2 profile.
- WMA1, WMA lossless / Voice are not supported.
- QCELP and AMR NB/WB are not supported.
- Vorbis is supported for up to 5.1 channels.
- Dolby Digital+ is supported for up to 5.1 channels.
- The supported sample rates are 8, 11.025, 12, 16, 22.05, 24, 32, 44.1, and 48 kHz, and differ with the codec.

### Image

- Compatible image file format: JPEG, PNG, BMP
  - ✎ 32-bit, 24-bit and 8-bit BMP files are supported.
- Supported maximum resolution: 7680 x 4320 (JPEG), 4096 x 4096 (PNG, BMP)
  - ✎ When playing 10 files in one LFD file - 5120 x 5120
- Supported maximum file size: 20MB
- Supported **Slideshow Effect**: 9 effects  
(**Fade1, Fade2, Blind, Spiral, Checker, Linear, Stairs, Wipe, Random**)

Power Point	PDF	WORD
<ul style="list-style-type: none"> <li>• Compatible document file formats               <ul style="list-style-type: none"> <li>– Extension : ppt, pptx, pps, ppsx</li> <li>– Version : Office 97 ~ Office 2019</li> </ul> </li> <li>• Functions not supported               <ul style="list-style-type: none"> <li>– Animation effect</li> <li>– 3D shapes (which will be displayed in 2D)</li> <li>– Header and footer (some subitems are not supported)</li> <li>– Word Art</li> <li>– Align                   <ul style="list-style-type: none"> <li>A group alignment error may occur</li> </ul> </li> <li>– Office 2007                   <ul style="list-style-type: none"> <li>SmartArt is not fully supported. 97 out of 115 subitems are supported.</li> </ul> </li> <li>– Object insertion</li> <li>– Half-width characters</li> <li>– Letter spacing</li> <li>– Charts</li> <li>– Vertical text                   <ul style="list-style-type: none"> <li>Some subitems are not supported</li> </ul> </li> </ul> </li> </ul>	<ul style="list-style-type: none"> <li>• Compatible document file formats               <ul style="list-style-type: none"> <li>– Extension : pdf</li> </ul> </li> <li>• Functions not supported               <ul style="list-style-type: none"> <li>– Content less than 1 pixel not supported because of performance degradation issue.</li> <li>– Mask image and tile image content is limitedly supported, depending on the performance of the shading pattern device.</li> <li>– 3D Shadow Effects not supported.</li> <li>– Some characters not supported (Special characters may be corrupted)</li> </ul> </li> </ul>	<ul style="list-style-type: none"> <li>• Compatible document file formats               <ul style="list-style-type: none"> <li>– Extension : .doc, .docx</li> <li>– Version : Office 97 ~ Office 2019</li> </ul> </li> <li>• Functions not supported               <ul style="list-style-type: none"> <li>– Page background effect</li> <li>– Some paragraph styles</li> <li>– Word Art</li> <li>– Align                   <ul style="list-style-type: none"> <li>A group alignment error may occur</li> </ul> </li> <li>– 3D shapes (which will be displayed in 2D)</li> <li>– Office 2007                   <ul style="list-style-type: none"> <li>SmartArt is not fully supported. 97 out of 115 subitems are supported.</li> </ul> </li> <li>– Charts</li> <li>– Half-width characters</li> <li>– Letter spacing</li> <li>– Vertical text                   <ul style="list-style-type: none"> <li>Some subitems are not supported</li> </ul> </li> </ul> </li> </ul>

# Schedule

Home → Features → Schedule →

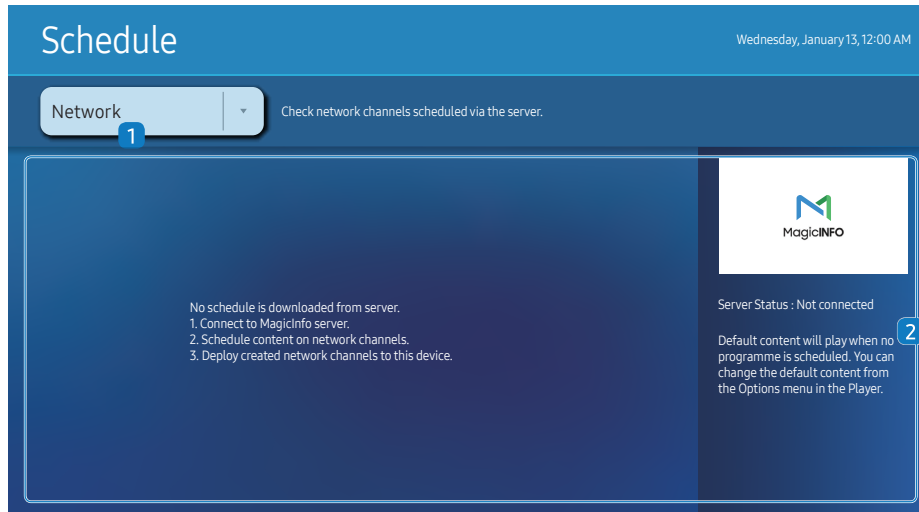

The displayed image may differ depending on the model.

You can check the schedule imported from a selected storage device.

This function may not be supported depending on the model.

No.	Description
1	Select the saved location of the schedule.
2	Create/Edit/Delete/View schedule of content playback.

## Web browser

🏠 → [Features](#) → Web browser → 📄



📄 The displayed image may differ depending on the model.

Connect the network to access the Internet from the product like accessing the Internet from a computer.

📄 This function may not be supported depending on the model.

### Settings

🏠 → [Features](#) → Web Browser → ▼ → [Settings](#) → 📄

#### Refresh Interval

Set the time for the web browser to wait before returning to the homepage.

- [Off](#) / [5 min](#) / [10 min](#) / [15 min](#) / [30 min](#)

#### Zoom

Set the zoom scale to apply when the web browser is refreshed.

- [50%](#) / [75%](#) / [100%](#) / [125%](#) / [150%](#) / [200%](#) / [300%](#)

#### Home Page

Set the website to display when the web browser is refreshed.

- [Samsung Display](#) / [Custom](#)

#### Custom

Enter the URL to set as the homepage.

- [Enter URL](#)

📄 Available only when [Home Page](#) is set to [Custom](#).

---

## Advanced Settings

General	
Hide Tabs and Toolbar automatically	If the browser tabs, menu or toolbar are not used for a while, they will automatically disappear. To make them appear again, move the pointer or focus to the top of the screen. <ul style="list-style-type: none"><li>• Use / Do not use</li></ul>
Hide Cursor in Touch Mode	Hide the cursor to prevent interference with touch operation. <ul style="list-style-type: none"><li>• Use / Do not use</li></ul>
Pop-up Blocker	Make your browsing experience more pleasant by blocking pop-up windows. <ul style="list-style-type: none"><li>• Use / Do not use</li></ul>
Proxy Server	Configure a proxy server for the web browser. <ul style="list-style-type: none"><li>• Use / Do not use</li></ul>
Reset Settings	All your customised Web Browser settings will be reset to their default values. Your browsing history won't be affected.

### Search Engine

If you enter a keyword in the URL/keyword input field, Web Browser will open the Search Results page. Choose the search engine you want to use.

- Google / Bing

---

### Privacy & Security

Do Not Track	Ask websites not to track you. <ul style="list-style-type: none"><li>• Use / Do not use</li></ul>
Delete History	Delete your entire browsing history.
JavaScript	Allow all sites to run JavaScript for a better browsing experience. <ul style="list-style-type: none"><li>• Use / Do not use</li></ul>
Delete browsing data	Delete all browsing data such as cookies, cached images and data. Your browsing history won't be affected.
Block Third-Party Cookies	Block third-party websites from saving and reading cookie data. Features on some sites may not work. <ul style="list-style-type: none"><li>• Use / Do not use</li></ul>

---

### Encoding

Encoding	Choose an encoding method for webpages. The current setting is Auto. <ul style="list-style-type: none"><li>• Auto / Manual (Current : Unicode)</li></ul>
----------	--

---

### About

Display the current version of Web Browser.

---

---

## Read Before Using the Web Browser Function

Read this information before using the Web Browser function.

- File download is not supported.
- The **Web Browser** function may not be able to access certain websites, including websites operated by certain companies.
- The product does not support playback of flash videos.
- E-commerce for online purchases is not supported.
- ActiveX is not supported.
- Only a limited number of fonts are supported. Certain symbols and characters may not be displayed properly.
- The response to remote commands and the resulting on-screen display may be delayed while a webpage is loading.
- Loading a webpage may be delayed or suspended completely depending on the status of the participating systems.
- Copy and paste operations are not supported.
- When composing an email or a simple message, certain functions such as the font size and colour selection may not be available.
- The number of access logs that can be saved is limited.
- The number of windows that can be opened concurrently is limited.
- Web browsing speed will differ with the network environment.
- Browsing history is saved from latest to oldest, with the oldest entries being overwritten first.
- Depending on the types of video/audio codecs supported, you may not be able to play certain HTML5 video and audio files.
- Video sources from PC-optimised streaming service providers may not play properly on our proprietary **Web Browser** browser.

---

## Custom Home

🏠 → **Features** → Custom Home → 🖱️



🖱️ The displayed image may differ depending on the model.

Enter your 6 digit PIN number. If you want to change the PIN number, use the **Change PIN** function.

Select an item to run in Custom Home mode. Press the Home key to return to this screen.

🖱️ This function may not be supported depending on the model.

---

## Screen Mirroring

🏠 → **Features** → Screen Mirroring → 📄

Follow the instructions on the screen to adjust the PC settings and wirelessly connect the Product to the PC.

📝 This function may not be supported depending on the model.

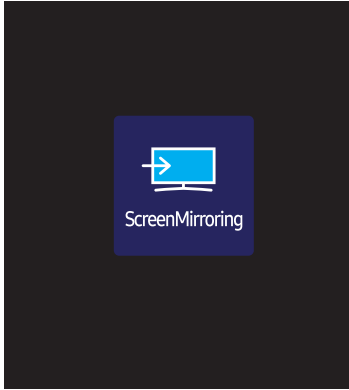

---

📝 The displayed image may differ depending on the model.

# Workspace

🏠 → [Features](#) → [Workspace](#) → 🖱️

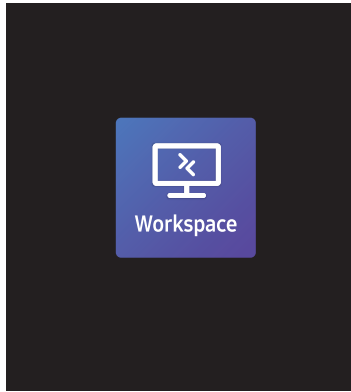

🖱️ The displayed image may differ depending on the model.

- 🖱️ This function may not be supported depending on the model.
- 🖱️ Make sure that the product is connected to the network.
- 🖱️ Be sure to connect your keyboard and mouse before starting this function.

Access to remote PC and your work resources with this function.

- **Window PC**  
**Remote PC:** This function allows you to connect your product to a remote PC or a cloud server.  
**Screen Sharing:** Share your Windows PC screen to your device.
  - 🖱️ Only PCs or Cloud Servers running on macOS/Windows 7 Pro or newer are supported.
- **Mac**  
**Remote Login:** Connect to Your Mac through Remote Login.
- **Samsung DeX:** Connect to your Samsung mobile device from your device.
  - 🖱️ This function may not be supported depending on the model.
- **Microsoft 365:** Collaborate with online versions of Microsoft 365.
- **VMware Horizon:** Provides access to **VMware Horizon** to businesses operating the VMware infrastructure with a Horizon account.
  - 🖱️ This function may not be supported depending on the model.

## SMARTVIEW+

🏠 → Features → SMARTVIEW+ → 🖥️

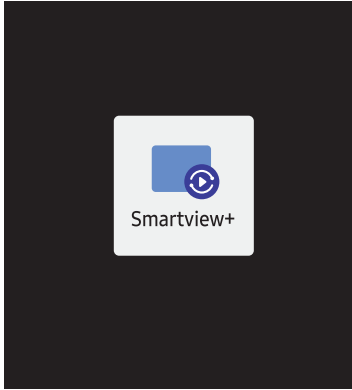

- You can view multiple content items through SMARTVIEW+.
- To start the function, select SMARTVIEW+, and then select the content to add in Select content. or select a desired combination in Preset at the top of SMARTVIEW+. Or run screen sharing for your mobile device.
- To share the screen of a PC, enter the address provided on the screen into your web browser (e.g., Chrome, Edge, Firefox or Safari).
- To share the screen of a mobile or tablet device, download and install the Samsung Signage Mobile App from the Samsung Apps, Google Play Store or Apple App Store, and then enter the numbers displayed on the screen.
- A maximum of 10 clients can be connected, and a maximum of 6 device screens can be shared at the same time.
- For a PC, you can directly control screen sharing by connecting as an administrator.
- 🖋️ For details on using this feature, refer to the on-screen instructions.
- 🖋️ This function may not be supported depending on the model.

🖋️ The displayed image may differ depending on the model.

---

# APPS

🏠 → [Features](#) → APPS → 📄

Manage and update your apps. To use the APPS Menu, please agree to the Terms and Conditions. Check details information of app and reinstall when the app does not work properly.

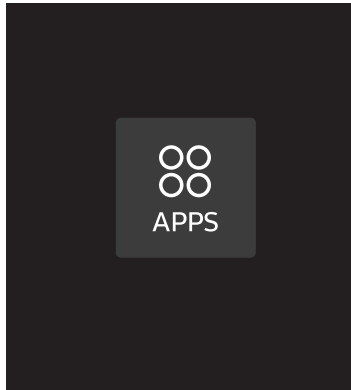

---

 The displayed image may differ depending on the model.

---

# Settings

Check the current network and Internet connection.

## Network

🏠 → Settings → Network → 📄

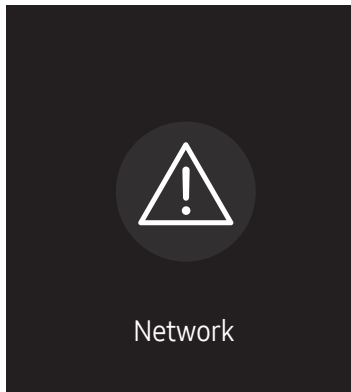

---

 The displayed image may differ depending on the model.

# Clone Product

🏠 → Settings → Clone Product → ↩️

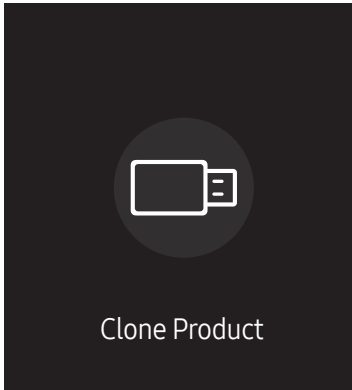

✎ The displayed image may differ depending on the model.

Export settings on the product to an external storage device. You can also import settings from an external storage device.

This option is useful when assigning the same settings to several products.

## When a duplicate file is not found on the external storage device

- 1 Connect the external storage device, then run the **Clone Product** function.
- 2 The **No cloning file found on the external storage device. Export this device's settings to the external storage device?** message appears.
- 3 Select **Export** to export the settings.

## When a duplicate file is found on the external storage device

- 1 Connect the external storage device, then run the **Clone Product** function.
- 2 The **Cloning file found. Please select an option.** message appears.  
Run the **Import from External Storage** or **Export to External Storage** function.
  - **Import from External Storage:** Copy settings saved on an external storage device to the product.
    - ✎ After configuration is complete, the product is rebooted automatically.
  - **Export to External Storage:** Copy settings on the product to an external storage device.

## ID Settings

🏠 → Settings → ID Settings → ↩

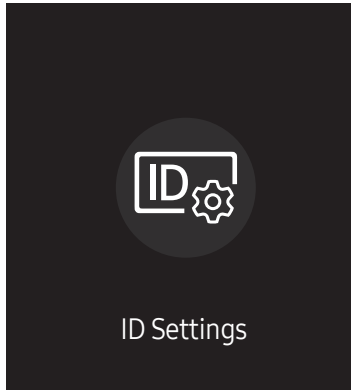

✎ The displayed image may differ depending on the model.

Assign an ID to a set.

### Device ID

Set a unique ID number for each product.

- ✎ Press ▲/▼ to select a number, and press ↩.
- ✎ Enter the number you want using the number buttons on the remote control.

### Device ID Auto Set

This feature automatically allots an ID number to a device connected through an RS232C cable.

- ✎ This function is only available on the first device within an RS-232C daisy chain.
- ✎ This function may not be supported depending on the model.

### PC Connection Cable

Select which type of cable you are using to connect the display to the PC.

- **RS232C cable**  
Communicate with MDC through the RS232C cable.
- **RJ-45 (LAN)/Wi-Fi Network** or **RJ-45 (LAN) Cable**  
Communicate with MDC through the RJ45 cable.

✎ Available functions may differ depending on the model.

## Video Wall

🏠 → Settings → Video Wall → 🗨️

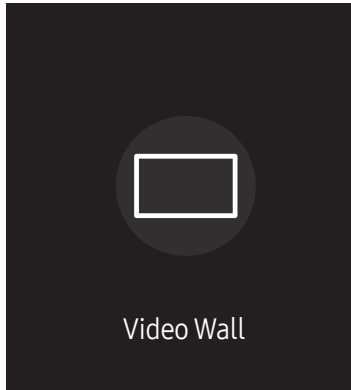

🔧 The displayed image may differ depending on the model.

Customise the layout of multiple displays that are connected to form a video wall.

In addition, display part of a whole picture or repeat the same picture on each of the connected multiple displays.

To display multiple images, refer to MDC Help or the MagicInfo user guide. Some models may not support the MagicInfo function.

🔧 This function may not be supported depending on the model.

### Video Wall

You can activate or deactivate **Video Wall**.

To organise a video wall, select **On**.

- **Off / On**

🔧 This feature only works with external input sources.

🔧 When an input source that is not external is enabled, the **Video Wall** feature is automatically set to **Off** and disabled.

### Horizontal x Vertical

This feature automatically splits a videowall display based on a videowall matrix configuration.

Enter the videowall matrix.

The videowall display is split based on the configured matrix. The number of vertical or horizontal display devices can be set within the range 1 and 15.

🔧 A videowall display can be split into a maximum of 225 screens.

🔧 The **Horizontal x Vertical** option is only enabled when **Video Wall** is set to **On**.

---

## Screen Position

To rearrange split screens, adjust the number for each product in the matrix using the **Screen Position** feature.

Selecting **Screen Position** will display the videowall matrix with the numbers assigned to the products that form the videowall.

To rearrange products, use the direction buttons on the remote control to move a product to another desired number. Press the  button.

 **Screen Position** allows you to split the screen into a maximum of 225 views (15 x 15).

 The **Screen Position** option is only enabled when **Video Wall** is set to **On**.

 To use the function, make sure **Horizontal x Vertical** is configured.

## Format

Select how to display images on the videowall display.

- **Full**: Display images in full screen with no margin.
- **Natural**: Display images in the original aspect ratio without enlarging or reducing the size.

 The **Format** option is only enabled when **Video Wall** is set to **On**.

## On/Off Timer

🏠 → Settings → On/Off Timer → 📄

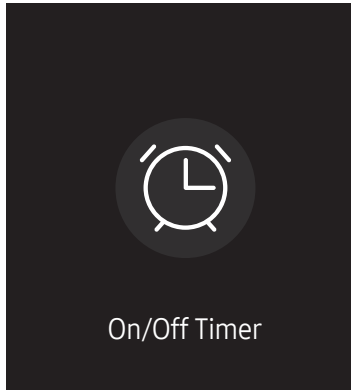

📝 The displayed image may differ depending on the model.

📝 You must set **Clock Set** before you can use this feature.

### On Timer

Set **On Timer** so that your product turns on automatically at a time and on a day of your choice.

The power is turned on with the specified volume or input source.

**On Timer:** Set the on timer by making a selection from one of the seven options. Ensure you set the current time first.

(**On Timer1 ~ On Timer7**)

- 📝 While the internal/USB memory option can be used with **On Timer** for **MagicInfo** mode, it is recommended to use an internal memory.
- 📝 Proper operation of **On Timer** feature cannot be guaranteed if used with a battery powered USB device, which can take longer to be recognised.
- **Setup:** Select **Don't Use**, **Once**, **Everyday**, **Mon~Fri**, **Mon~Sat**, **Sat~Sun** or **Manual**. If you select **Manual**, you can choose the days you want **On Timer** to turn on your product.
  - The check mark indicates days you've selected.
- **Time:** Set the hour and minute. Use the number buttons or the up and down arrow keys to enter numbers. Use the left and right arrow buttons to change entry fields.
- **Volume** (For models with built-in speakers): Set the desired volume level. Use the up and down arrow buttons to change the volume level.
- **Sources:** Select the input source of your choice.
- **Content** (when the **Sources** is set to **Internal/USB** for **MagicInfo** mode): From the USB device or internal memory, select a file (e.g. music, photo, or video) to play just after the product is turned on.

---

## Off Timer

Set the off timer (**Off Timer**) by making a selection from one of the seven options. (**Off Timer1 ~ Off Timer 7**)

- **Setup:** Select **Don't Use, Once, Everyday, Mon~Fri, Mon~Sat, Sat~Sun** or **Manual**. If you select **Manual**, you can choose the days you want **Off Timer** to turn off your product.
  - The check mark indicates days you've selected.
- **Time:** Set the hour and minute. Use the number buttons or the up and down arrow keys to enter numbers. Use the left and right arrow buttons to change entry fields.

## Holiday Management

Timer will be disabled during a period specified as a holiday.

- **Add Holiday:** Specify the period you want to add as a holiday.  
Select the start and end dates of the holiday you want to add using the ▲/▼ buttons, and click the **Done** button.  
The period will be added to the list of holidays.
  - **Start Date:** Set the start date of the holiday.
  - **End Date:** Set the end date of the holiday.
- **Delete:** Delete selected items from the list of holidays.
- **Edit:** Select a holiday item and then change the date.
- **Apply to Timers:** Set the **On Timer** and **Off Timer** to not activate on public holidays.
  - Press  to select the **On Timer** and **Off Timer** settings you do not want to activate.
  - The selected **On Timer** and **Off Timer** will not activate.

# Ticker

🏠 → Settings → Ticker → 📄

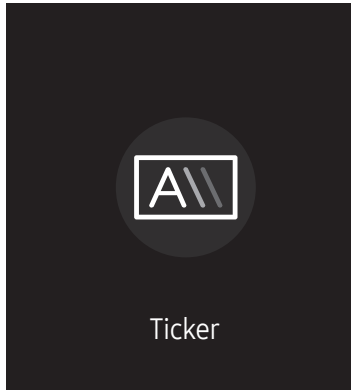

Input text while a video or image is displayed and display the text on the screen.

✎ You must set **Clock Set** before you can use this feature.

✎ This feature only works with external input sources.







- **Off / On:** Set whether or not to use **Ticker**.
- **Message:** Enter a message to display on the screen.
- **Time:** Set the **Start Time** and **End Time** to display a **Message**.
- **Font options:** Specify the text font and colour for the message.
- **Position:** Select a position to display a **Message**.
- **Scroll:** Turn scroll effects of **Ticker** on or not. Specify the scroll **Direction** and **Speed** for the message.
- **Preview:** Preview your **Ticker** settings.





✎ The displayed image may differ depending on the model.

# Chapter 06

## Menu

### Picture

2nd	3rd	Description
<b>Smart Calibration</b>		Use the Smart Calibration app, installed on your mobile device, to adjust the picture quality of the display.  This function may not be supported depending on the model.
<b>Backlight / Brightness / Contrast / Sharpness</b>		Your product has several options for adjusting picture quality.  You can adjust and store settings for each external device you have connected to an input on the product.  Lowering picture brightness reduces power consumption.  You may adjust the brightness of your display to achieve maximum level by going to <b>Backlight</b> and <b>Contrast</b> to 100(max).  Due to the characteristics of the display panels, brightness level of individual products may vary.
<b>Colour Temperature</b>		It sets colour temperature. The value and temperature increase simultaneously, so the ratio of blue colour rises. (Range: 2800K–16000K)  Enabled when <b>Colour Tone</b> is set to <b>Off</b> .
<b>Advanced Settings</b>		Configure advanced picture settings to create your preferred picture.
	<b>Picture Enhancer</b>	Displays enhanced colour and sharpness.
	<b>Colour</b>	Adjust the colour saturation levels. Colour saturation intensifies as the value nears 100. (Range: 0~100)
	<b>Tint (G/R)</b>	Adjust the ratio of green to red tint levels. Increasing values intensifies the saturation of red and green colours. (Range: 0~50)





2nd	3rd	Description
Advanced Settings	White Balance	<p>Adjust the colour temperature of the picture so that white objects appear brighter.</p> <ul style="list-style-type: none"> <li>• <b>2 Point</b> Adjust red, green, and blue luminosity levels in two sections for precise white balance optimisation.</li> <li>• <b>20 Point Settings</b> Controls the white balance in 20 point interval by adjusting the red, green, and blue brightness. <ul style="list-style-type: none"> <li>– <b>20 Point</b> Adjust red, green, and blue luminosity levels in twenty sections for precise white balance optimisation.</li> </ul> </li> </ul> <p> Some external devices may not support this function.</p>
	Gamma	<p>Adjust the mid-range brightness of the picture.</p> <p> <b>Gamma</b> settings <b>HLG, ST.2084</b>, and <b>BT.1886</b> may change depending on the input video settings. For models with the <b>HDR+ Mode</b> support, the <b>Gamma</b> settings <b>HLG, ST.2084</b>, and <b>BT.1886</b> may change depending on the input video and <b>HDR+ Mode</b> settings. If <b>HDR+ Mode</b> is set to <b>Off</b>, <b>HLG, ST.2084</b>, and <b>BT.1886</b> settings may be available depending on the input video. To adjust <b>S Curve</b>, set <b>HDR+ Mode</b> to <b>Off</b>.</p> <ul style="list-style-type: none"> <li>• <b>HLG / ST.2084 / BT.1886 / 2.2 / S Curve</b> Adjust the <b>HLG, ST.2084, BT.1886, S Curve</b> levels of the picture. <ul style="list-style-type: none"> <li> If <b>2.2</b> is selected, level adjustment is not possible.</li> <li> Available functions may differ depending on the port type.</li> </ul> </li> </ul>
	Contrast Enhancer	Automatically balance the contrast to prevent excessive differences between bright and dark areas.
	Black Tone	Select the black level to adjust the screen depth.
	Flesh Tone	Adjust the flesh tone colour by increasing or decreasing red levels.

2nd	3rd	Description
Advanced Settings	Colour Space Settings	<p>Configure colour space settings to refine the spectrum of colours on your screen.</p> <ul style="list-style-type: none"> <li> <b>Colour Space</b>            Choose a colour space.           <ul style="list-style-type: none"> <li>To adjust <b>Colour</b>, <b>Red</b>, <b>Green</b>, <b>Blue</b> and <b>Reset</b>, set <b>Colour Space</b> to <b>Custom</b>.</li> </ul> </li> <li> <b>Colour Gamut</b>            Choose a colour gamut.           <ul style="list-style-type: none"> <li>This function may not be supported depending on the model.</li> </ul> </li> </ul>
	Input Signal Plus	<p>Expands the input signal range for HDMI connections.</p> <ul style="list-style-type: none"> <li>SM55HX-P, SM85HX-P            When <b>Input Signal Plus</b> is set to <b>On</b>, up to the 3840 x 2160 @ 60 Hz resolution is supported.            When <b>Input Signal Plus</b> is set to <b>Off</b>, up to the 3840 x 2160 @ 30 Hz resolution is supported.</li> <li>Connecting parts may differ depending on the model.</li> <li>This function may not be supported depending on the model.</li> </ul>
	Motion Lighting	<p>Reduces power consumption by reducing screen brightness when the picture on the screen is in motion.</p>
Picture Options	Colour Tone	<p>Select the colour tone that best suits your viewing preferences.</p> <ul style="list-style-type: none"> <li>Settings can be adjusted and stored for each external device connected to an input on the product.</li> <li>Available options may vary depending on the product.</li> </ul>
	Digital Clean View	<p>Reduce picture noise to avoid distractions such as flickering.</p>
	HDMI Black Level	<p>Adjust the black level to optimise the HDMI picture brightness and contrast.</p> <ul style="list-style-type: none"> <li>Only available if the input signal from the external device connected to the HDMI port is RGB444.</li> </ul>
	Film Mode	<p>Make frame transitions from older video sources smoother. This function is only available when the input signal is TV, AV, Component (480i, 1080i), or HDMI (1080i).</p>
	Dynamic Backlight	<p>Automatically adjust the backlight to provide the best possible screen contrast under the current conditions.</p>



2nd	3rd	Description
<b>Apply Picture Settings</b>		Apply the picture settings to all external devices connected to the device or to the current source only.
<b>Picture Size Settings</b>		Choose size and aspect ratio picture displayed on screen. ✎ Some external devices and applications may not support this function.
	<b>Picture Size</b>	Different screen adjustment options are displayed depending on the current input source. ✎ Available functions may differ depending on the model or input signals. ✎ Do not set your product to <b>4:3</b> format for a long time. The borders displayed on the left and right, or top and bottom of the screen may cause image retention (screen burn) which is not covered by the warranty.
	<b>Fit to screen</b>	Adjusts the picture position. When selected, the full programme image will be displayed. No part of the image will be cut off.
	<b>Zoom and Position</b>	Adjusts the picture zoom and position. This function is available only if <b>Picture Size</b> is set to <b>Custom</b> . ✎ If you want to reset the picture to its original position, select <b>Reset</b> in the <b>Zoom and Position</b> screen. The picture will be set to its default position.
<b>Reset Picture</b>		Restore all picture settings to the factory default.

---









## OnScreen Display









2nd	3rd	Description
Display Orientation	Source Content Orientation	Select whether source content should be displayed in landscape or portrait mode.
	Aspect Ratio	Set the rotated screen to be either full screen or original.  Available only when <b>Source Content Orientation</b> is set to <b>Portrait</b> .
Screen Protection	Screen Saver	Activate a screensaver when your device displays a still image for two hours or more.
	Screen Burn Protection	To reduce the possibility of screen burn, this unit is equipped with <b>Screen Burn Protection</b> screen burn prevention technology. <b>Screen Burn Protection</b> moves the picture slightly on the screen. <ul style="list-style-type: none"><li>• <b>Pixel Shift</b> Minimise image retention by finely moving pixels horizontally or vertically.  <b>Horizontal, Vertical</b> and <b>Time</b> are enabled only when <b>Pixel Shift</b> is set to <b>On</b>.  The <b>Pixel Shift</b> value may differ depending on the model.  Displaying a still image or a <b>4:3</b> output for an extended period of time may cause image retention. This is not a defect in the product.</li><li>• <b>Timer</b> You can set the timer for <b>Screen Burn Protection</b>. The <b>Screen Burn Protection</b> feature stops automatically after a specified period of time.</li><li>• <b>Immediate display</b> Select the screen saver you want to display immediately.</li></ul>

---

2nd	3rd	Description
Message Display	Source Info	Select whether to display the source OSD when the input source changes.
	No Signal Message	Select whether to display the no-signal OSD when no signal is detected. The message <b>No Cable Connected</b> will appear if no source device is connected.
	MDC Message	Select whether to display the MDC OSD when the product is controlled by the MDC.
	Rotation Message	Receive a warning message when the display device is rotated to an inappropriate angle.  This function may not be supported depending on the model.
Language		Set the menu language.  A change to the language setting will only be applied to the onscreen menu display. It will not be applied to other functions on your PC.
Reset OnScreen Display		This option returns the current settings under <b>OnScreen Display</b> to the default factory settings.

## Sound

2nd	3rd	Description
<b>Sound Mode</b>		<p>You can select a sound mode to suit your personal preferences.</p> <ul style="list-style-type: none"><li> This function is disabled when <b>Sound Output</b> is set to <b>External</b> or <b>Receiver (HDMI)</b>.</li><li> This function may not be supported depending on the model.</li></ul>
<b>Balance</b>		<p>Adjust speaker volume levels for sound balance optimisation.</p> <ul style="list-style-type: none"><li> This function is disabled when <b>Sound Output</b> is set to <b>External</b> or <b>Receiver (HDMI)</b>.</li><li> Available functions may differ depending on the model.</li><li> This function may not be supported depending on the model.</li></ul>
<b>Equaliser</b>		<p>Adjust the equaliser to customise the volume and pitch, and enhance the richness of the sound output.</p> <ul style="list-style-type: none"><li> Available only when <b>Sound Mode</b> is set to <b>Standard</b>.</li><li> This function is disabled when <b>Sound Output</b> is set to <b>External</b> or <b>Receiver (HDMI)</b>.</li><li> This function may not be supported depending on the model.</li></ul>
<b>Digital Output Audio Format</b>		<p>Select the digital audio output format. When <b>Pass-through</b> is selected, the input audio will be sent to the receiver without any processing. This option is only supported when the source is HDMI and the receiver is connected through HDMI eARC or ARC.</p> <ul style="list-style-type: none"><li> This function may not be supported depending on the model.</li></ul>

2nd	3rd	Description
<p><b>Sound Output</b></p>		<p>Select speakers for sound output.</p> <ul style="list-style-type: none"> <li> When you set <b>Sound Output</b> to <b>External</b> or <b>Receiver (HDMI)</b>, the internal speaker is turned off. You will hear sound through the external speakers only.</li> <li> The audio is available both for internal and external speakers while connected through the AUDIO OUT port with the <b>Sound Output</b> option set to <b>Internal</b>. Connecting parts may differ in different products.</li> <li> To select the <b>Receiver (HDMI)</b> option, set <a href="#">Anynet+ (HDMI-CEC)</a> to <b>On</b> while the product is connected to the AV Receiver's HDMI(ARC) port.</li> <li> If there is no video signal, both the products speakers and the external speakers will be mute.</li> <li> This function may not be supported depending on the model.</li> </ul>
<p><b>Auto Volume</b></p>		<p>Automatically adjusts the volume level when you change video sources or content so the level remains the same.</p> <ul style="list-style-type: none"> <li> To use the volume control of a connected source device, set <b>Auto Volume</b> to <b>Off</b>.</li> <li> This function is disabled when <b>Sound Output</b> is set to <b>External</b> or <b>Receiver (HDMI)</b>.</li> <li> This function may not be supported depending on the model.</li> </ul>
<p><b>Reset Sound</b></p>		<p>Reset all sound settings to the factory defaults.</p> <ul style="list-style-type: none"> <li> This function may not be supported depending on the model.</li> </ul>

---

## Network

2nd	3rd	Description
<a href="#">Network Status</a>		You can check the current network and Internet status.
<a href="#">Open Network Settings</a>		Configure network settings to connect to an available network.
	<a href="#">Network Type</a>	 <a href="#">Network Type</a> menu may not be available in Wired models.

## Network Settings (Wired)

### Connecting to a Wired Network

There are three ways to attach your product to your LAN using cable.

- You can attach your product to your LAN by connecting the LAN port on the back of your product to an external modem using a LAN cable. See the diagram below.

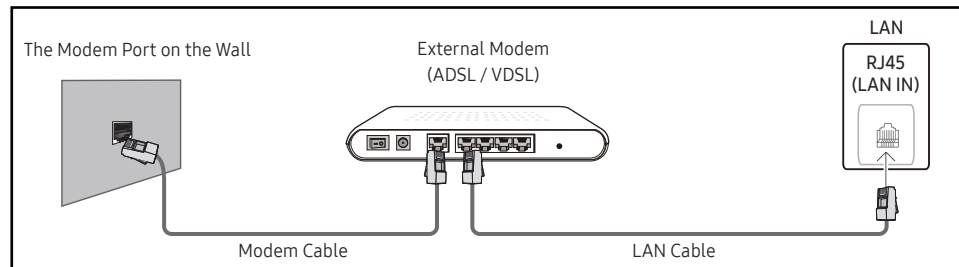

- You can attach your product to your LAN by connecting the LAN port on the back of your product to an IP Sharer which is connected to an external modem. Use LAN cable for the connection. See the diagram below.

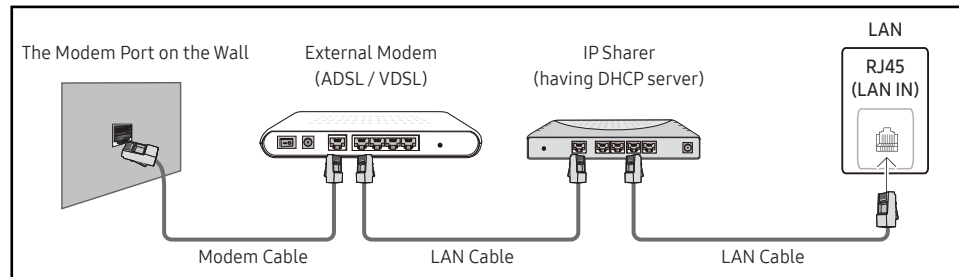

- Depending on how your network is configured, you may be able to attach your product to your LAN by connecting the LAN port on the back of your product directly to a network wall outlet using a LAN cable. See the diagram below. Note that the wall outlet is attached to a modem or router elsewhere in your house.

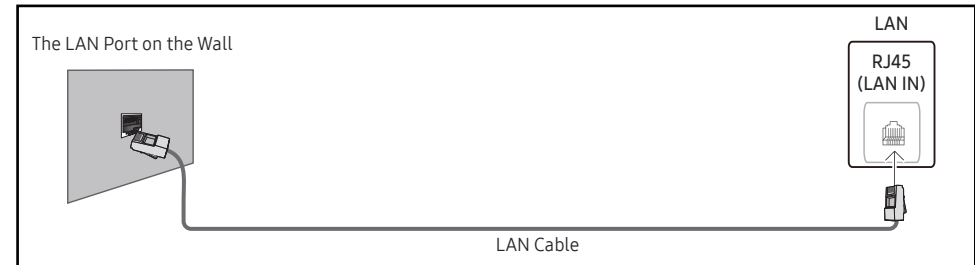

If you have a Dynamic Network, you should use an ADSL modem or router that supports the Dynamic Host Configuration Protocol (DHCP). Modems and routers that support DHCP automatically provide the **IP Address**, **Subnet Mask**, **Gateway**, and DNS values your product needs to access the Internet so you do not have to enter them manually. Most home networks are Dynamic Networks.

Some networks require a Static IP address. If your network requires a Static IP address, you must enter the **IP Address**, **Subnet Mask**, **Gateway**, and DNS values manually on your product **IP Settings** when you set up the network connection. To get the **IP Address**, **Subnet Mask**, **Gateway**, and DNS values, contact your Internet Service Provider (ISP).

If you have a Windows computer, you can also get these values through your computer.

- ✎ You can use ADSL modems that support DHCP if your network requires a Static IP address.
- ✎ ADSL modems that support DHCP also let you use Static IP addresses.

---

Set the network connection to use Internet services such as perform software upgrades.

## Automatic Open Network Settings (Wired)

Connect to the network using a LAN cable.

Make sure a LAN cable is connected first.

### How to set up automatically

- 1 Set **Network Type** to **Wired** from the **Open Network Settings** page.

 For wired models, select **Network Status** menu.

- 2 The network test screen appears and verifies the network connection.

When the connection has been verified, the **“Success! Your device is connected to the Internet. If you have any problems using online services, please contact your Internet service provider.”** message appears.

 If the connection process fails, check the LAN port connection.

 If the automatic process cannot find the network connection values or if you want to set the connection manually, go to the next section(Manual Open Network Settings (Wired)).

## Manual Open Network Settings (Wired)

Offices may use static IP addresses.

If this is the case, ask the network administrator for the **IP Address**, **Subnet Mask**, **Gateway** and DNS server address. Enter these values manually.

### Getting the Network Connection Values

To view the Network connection values on most Windows computers, follow these steps.

- 1 Right click the Network icon on the bottom right of the screen.
- 2 In the pop-up menu that appears, click Status.
- 3 On the dialog that appears, click the **Support** tab.
- 4 On the **Support** Tab, click the **Details** button. The Network connection values are displayed.

 The path to the settings depends on the installed OS.

### How to set up manually

- 1 Set **Network Type** to **Wired** from the **Open Network Settings** page.

The network test screen appears and the verification process starts. Press **Cancel**. The verification process stops.

 For wired models, select **Network Status** menu.

- 2 Select **IP Settings** on network connection screen. The **IP Settings** screen appears.

- 3 Select the field at the top, press , and then set **IP setting** to **Enter manually**. Repeat the entry process for each field in the **IP Address**.

 Setting **IP setting** to **Enter manually** automatically changes **DNS setting** to **Enter manually**.

- 4 When done, select **OK** at the bottom of the page, and then press . The network test screen appears and the verification process starts.

- 5 When the connection has been verified, the **“Success! Your device is connected to the Internet. If you have any problems using online services, please contact your Internet service provider.”** message appears.

## Network Settings (Wireless)

- ✎ This function may not be supported depending on the model.
- ✎ When the network is connected, it enables Multiple Display Control, Device Discovery, DLNA, Log Downloader, MagicInfo Backup play, SNMP and SmartThings. Services supported by software updates are subject to change.
- ✎ To use Wi-Fi Direct, the mobile device must support the Wi-Fi Direct function. To check whether your mobile device supports Wi-Fi Direct, refer to the mobile device's user manual.
- ✎ To ensure safe and secure use of the product, connect to the network using a securely managed router.

## Connecting to a Wireless Network

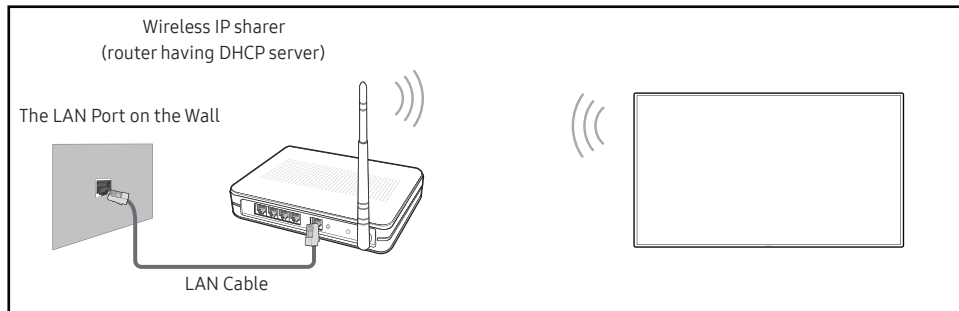

Samsung recommends using IEEE 802.11n. When you play video over a network connection, the video may not play smoothly.

- ✎ Select a channel for the wireless IP sharer that is not currently being used. If the channel set for the wireless IP sharer is currently being used by another device nearby, this will result in interference and communication failure.
- ✎ Your product supports only the following wireless network security protocols.
  - Authentication Modes: WEP, WPAPSK, WPA2PSK
  - Encryption Types: WEP, TKIP, AESIn compliance with the Wi-Fi certification specifications, Samsung products do not support WEP or TKIP security encryption in networks running in the High-throughput(Greenfield) 802.11n mode.
- ✎ If your wireless router supports WPS (Wi-Fi Protected Setup), you can connect to the network through PBC (Push Button Configuration) or PIN (Personal Identification Number). WPS will automatically configure the SSID and WPA key in either mode.
- ✎ Connection Methods: You can setup the wireless network connection in three ways. Automatic Network Setup, Manual Network Setup, **Use WPS**

---

## Automatic Network Setup (Wireless)

Most wireless networks have an optional security system that requires devices that access the network to transmit an encrypted security code called an Access or Security key. The Security key is based on a Pass Phrase, typically a word or a series of letters and numbers of a specified length you were asked to enter when you set up security for your wireless network. If you use this method of setting up the network connection, and have a Security key for your wireless network, you will have to enter the Pass Phrase during the automatic or manual setup process.

### How to set up automatically

- 1 Set **Network Type** to **Wireless** from the **Open Network Settings** page.
- 2 The **Network** function searches for available wireless networks. When done, it displays a list of the available networks.

In the list of networks, press the ▲ or ▼ button to select a network, and then press the  button.

 If the desired wireless router does not appear, select **Refresh** to search again.

 If the router cannot be found after retrying, select the **Add Network**.

- 3 If the **Enter the password for (AP Name)** screen appears, go to step 4. If you select a wireless router that does not have security, go to step 6.
- 4 If the router has security, enter the **Enter the password for (AP Name)**. (Security key or PIN).
- 5 When done, use the right arrow button to move the cursor to **Done**, and then press . The network connection screen appears and the verification process starts.

 A connection with the router is established, but the Internet cannot be accessed. In this case, contact your Internet service provider.
- 6 When the connection has been verified, the **“Success! Your device is connected to the Internet. If you have any problems using online services, please contact your Internet service provider.”** message appears.

## Manual Network Setup (Wireless)

Offices may use static IP addresses.

If this is the case, ask the network administrator for the **IP Address, Subnet Mask, Gateway** and DNS server address. Enter these values manually.







### Getting the Network Connection Values

To view the Network connection values on most Windows computers, follow these steps.

- 1 Right click the Network icon on the bottom right of the screen.
- 2 In the pop-up menu that appears, click Status.
- 3 On the dialog that appears, click the **Support** tab.
- 4 On the **Support** Tab, click the **Details** button. The Network connection values are displayed.

---

## How to set up manually

- 1 Set **Network Type** to **Wireless** from the **Open Network Settings** page.
- 2 The **Network** function searches for available wireless networks. When done, it displays a list of the available networks.
- 3 In the list of networks, press the ▲ or ▼ button to select a network, and then press the  button twice.
  -  If the desired wireless router does not appear, select **Refresh** to search again.
  -  If the router cannot be found after retrying, select the **Stop** button. The **Add Network** button appears.
- 4 If the **Enter the password for (AP Name)** screen appears, go to step 5. If you select a wireless router that does not have security, go to step 7.
- 5 If the router has security, enter the **Enter the password for (AP Name)**. (Security key or PIN).
- 6 When done, use the right arrow button to move the cursor to **Done**, and then press . The network connection screen appears and the verification process starts.
- 7 Select **Cancel** while network connections are being attempted. This will stop the connection.
- 8 Select **IP Settings** on network connection screen. The **IP Settings** screen appears.
- 9 Select the field at the top, press , and then set **IP setting** to **Enter manually**. Repeat the entry process for each field in the **IP Address**.
  -  Setting **IP setting** to **Enter manually** automatically changes **DNS setting** to **Enter manually**.
- 10 When done, select **OK** at the bottom of the page, and then press . The network test screen appears and the verification process starts.
- 11 When the connection has been verified, the “**Success! Your device is connected to the Internet. If you have any problems using online services, please contact your Internet service provider.**” message appears.







## Use WPS

 This function may not be supported depending on the model.



### How to set up using Use WPS

If your router has a **Use WPS** button, follow these steps.

- 1 Set **Network Type** to **Wireless** from the **Open Network Settings** page.
- 2 Select **Use WPS**, press .
- 3 Press the WPS or PBC button on your wireless router within the next two minutes. Your product automatically acquires all the network setting values it needs and connects to your network.
  - If you want to use the WPS PIN, select **WPS PIN**.  
Go to your wireless router's Settings, enter your PIN, and then select **OK**.
- 4 The network connection screen appears, and network setup is done.



2nd	3rd	Description
<b>Server Network Settings</b>	<b>Connect to server</b>	<p>Connect to MagicInfo server.</p> <ul style="list-style-type: none"> <li> If you do use the <b>TLS</b> option, the server is configured to use https and data transfer is encrypted. (Port number: 7002)</li> <li> If you don't use the <b>TLS</b> option, enter the server IP address and port number. Use 7001 as the port number. (If you are unable to connect to the server using port number 7001, check with your server administrator to find the correct port number and then change the port number.)</li> <li> Enter the server IP address and port number. Use 7001 as the port number. (If unable to connect to the server using port number 7001, check with your server administrator to find the correct port number and then change the port number.)</li> <li> For the MagicInfo Server user guide, visit the following website: <a href="http://www.samsung.com/business">http://www.samsung.com/business</a> → Support → Resources → MagicInfo Web Manual.</li> </ul>
	<b>Verify MagicINFO Server</b>	Enable this option to block HTTPS communication if the domain name of the MagicINFO Server URL is different from the domain name of the MagicINFO Server certificate.
	<b>MagicInfo Mode</b>	<p>Select the appropriate <b>MagicInfo Mode</b> depending on the environment where you are using the product.</p> <ul style="list-style-type: none"> <li> Supported content types may be limited while <b>MagicInfo Mode</b> is set to <b>Lite</b>.</li> </ul>
	<b>Server Access</b>	Allow or deny access to MagicInfo server.
	<b>FTP Mode</b>	Specify the FTP operating mode.
	<b>Proxy server</b>	<p>Set up your proxy server connection and related functions.</p> <ul style="list-style-type: none"> <li> <b>Address / Port / ID</b> and <b>Password</b> are enabled only when <b>Proxy server</b> is set to <b>On</b>.</li> </ul>





2nd	3rd	Description
<p><b>Server Network Settings</b></p>	<p><b>UEM Setting</b></p>	<p>Configure settings for connection to the UEM (Unified Endpoint Management) server including Crestron.</p> <p>Enter the required information according to the guide for the server you want to connect to.</p> <p> The device information is sent to the UEM server while its connection is maintained. By resetting the settings, the configuration can be deleted, disabling the connection.</p> <ul style="list-style-type: none"> <li>• <b>Crestron</b> Configure Crestron server connection setting and connect to the server by pressing <b>Save</b> button. <ul style="list-style-type: none"> <li>– <b>XiO</b> Connect to XiO server, and its default operating server URL is entered in advance. If you want to connect both XiO and other Crestron server type at the same time, connect to XiO server first and then connect to other Crestron server type.</li> <li>– <b>Control System</b> Connect Control System server of which its connection configuration is set by <b>Server Address, Port, IP ID</b>. Crestron's auto discovery feature is supported by <b>Auto Discovery</b> option. Secure Connection is supported by setting <b>Secure Connection, Authentication ID, Authentication Password</b>. If you set <b>Verify Certificate</b> as off, then certificate verification is skipped during Secure Connection. A certificate can be installed into the device by <b>System → Security → Certificate Manager → App Certificate</b>.</li> <li>– <b>VC-4</b> Connect VC-4 server of which its connection configuration is set by <b>Server Address, Port, IP ID, Room ID</b>. Crestron's auto discovery feature is supported by <b>Auto Discovery</b> option. Secure Connection is supported by setting <b>Secure Connection, Authentication ID, Authentication Password</b>. If you set <b>Verify Certificate</b> as off, then certificate verification is skipped during Secure Connection. A certificate can be installed into the device by <b>System → Security → Certificate Manager → App Certificate</b>.</li> <li>– <b>Fusion</b> If you set <b>Outbound Connection</b> as on, then your device will be waiting for connection from Fusion server. If you set <b>Outbound Connection</b> as off, then connect Fusion server of which its connection configuration is set by <b>Server Address, Port</b>. Secure Connection is supported by setting <b>Secure Connection</b> only for <b>Outbound Connection</b> off option.</li> </ul> </li> <li>• <b>UEM Status</b> You can view current UEM app operating status or reset the settings by pressing <b>Reset</b> button.</li> </ul>



2nd	3rd	Description
<b>Embedded Server Settings</b>	<b>Embedded Server</b>	<p>Turn on to enable the embedded server. Turn off to delete registered server information.</p> <p>Turn on the embedded web server for managing devices using the web browser on your PC / mobile device.</p> <p>When the web server is set to <b>Client</b> mode, the registered server address is displayed, along with whether or not the server is registered, at the bottom of the Help page.</p>
	<b>Server Mode</b>	<p>To use this device as a local web server, set it to 'Server'. If you already have a server device nearby, set it as 'Client' to connect this device to the server.</p> <p>The embedded web server can be set to either of the following two modes.</p> <ul style="list-style-type: none"> <li>• <b>Server</b> <ul style="list-style-type: none"> <li>– When it is set to <b>Server</b> mode, you can control devices by accessing the following URL from your PC / mobile device: <code>https://device-ip:4000</code></li> <li>– When accessing for the first time, you should set the initial password before using the server.</li> <li>– Use the "Register Device" menu to register and control other devices that are set to <b>Client</b> mode.</li> </ul> </li> <li>• <b>Client</b> <ul style="list-style-type: none"> <li>– When it is set to <b>Client</b> mode, you can register devices to a supported server.</li> <li>– If you turn the <b>Embedded Server</b> feature off and on again while in <b>Client</b> mode, all information is reset and you should register devices again from the server.</li> </ul> </li> </ul> <p> CAUTION: Ensure that all devices and your PC / mobile device are connected to the same local network.</p>
<b>Wi-Fi</b>		<p>Enable or disable the Wi-Fi. Turn on this option to use features that require a Wi-Fi connection.</p> <p> This function may differ depending on the model.</p>
<b>Device Name</b>		<p>Select or enter a device name.</p> <p>This name can be shown on network device over the network.</p>

# System

2nd	3rd	Description
Accessibility	Voice Guide Settings	<ul style="list-style-type: none"><li>• <b>Voice Guide</b> Switch <b>Voice Guide</b> on or off. The language used for <b>Voice Guide</b> will be the same as the current menu language.<ul style="list-style-type: none"><li>✎ <b>Volume, Speed</b> and <b>Pitch</b> are enabled only when <b>Voice Guide</b> is set to <b>On</b>.</li><li>✎ The availability may vary depending on the region.</li></ul></li><li>• <b>Volume</b> Set the volume level for the <b>Voice Guide</b>.</li><li>• <b>Speed</b> Set the speed of the <b>Voice Guide</b>.</li><li>• <b>Pitch</b> Tune the pitch of the <b>Voice Guide</b>.</li><li>• <b>Background Sound Volume</b> Adjust background sound volume during voice guidance.<ul style="list-style-type: none"><li>✎ This function may differ depending on the model or geographical area.</li></ul></li></ul>
	<b>High Contrast</b>	Set the background and font to high-contrast colours in Menu. Menu transparencies become opaque when the option is selected.
	<b>Zoom Menu and Text</b>	Make the menu and text larger.
	<b>SeeColors Mode</b>	Allows users with colour blindness to experience rich colours. Enable this feature to customise colours to suit your viewing conditions, to experience richer colours on the screen. <ul style="list-style-type: none"><li>✎ Some menus are not available when <b>SeeColors Mode</b> is in use.</li><li>✎ This function may not be supported depending on the model.</li></ul>

2nd	3rd	Description
<b>Start Setup</b>		<p>Go through the initial setup steps like you did the first time you used this product.</p> <ul style="list-style-type: none"> <li>✎ Enter your 6 digit PIN number. If you want to change the PIN number, use the <b>Change PIN</b> function.</li> <li>✎ Change the PIN to keep your device secure.</li> </ul>
<b>Zero Touch Configuration</b>		<p>Set up the device through <b>Tizen Business Manager</b>. Before using <b>Zero Touch Configuration</b>, register the device at <b>Tizen Business Manager</b>.</p>
<b>Touch Control</b>		<p>Set the functions related to touch control.</p>
	<b>Touch Control</b>	<p>Prevent touch gestures from controlling your device.</p> <ul style="list-style-type: none"> <li>✎ This function may not be supported depending on the model.</li> </ul>
	<b>Admin Menu Lock</b>	<p>Set the <b>Admin Menu Lock</b> to display the administrator settings menu when you touch and hold the finger on the screen.</p> <ul style="list-style-type: none"> <li>✎ Available only when <b>Touch Control</b> is set to <b>On</b>.</li> </ul>
<b>Time</b>		<p>You can configure <b>Clock Set</b> or <b>DST</b>. Configure various time-related settings.</p>
	<b>Clock Set</b>	<p>Select <b>Clock Set</b>. Select <b>Date</b> or <b>Time</b>, and then press .</p> <p>Use the number buttons to enter numbers or press the up and down arrow buttons. Use the left and right arrow buttons to move from one entry field to the next. Press  when done.</p> <ul style="list-style-type: none"> <li>✎ You can set the <b>Date</b> and <b>Time</b> directly by pressing the number buttons on the remote control.</li> </ul>
	<b>NTP Settings</b>	<p>Set up the server URL and time zone to use the network time.</p>
	<b>DST</b>	<p>Switches the DST (Daylight Saving Time) function on or off.</p> <ul style="list-style-type: none"> <li>✎ <b>Start Date</b>, <b>End Date</b> and <b>Time Offset</b> are enabled only when <b>DST</b> is set to <b>On</b>.</li> </ul>
	<b>Power On Delay</b>	<p>When connecting multiple products, adjust the power-on time for each product to prevent power overload (within the range 0–50 seconds).</p>

2nd	3rd	Description
Auto Source Switching	Auto Source Switching	Switch to preset source or another source when the main source device gets disconnected.
	Primary Source Recovery	Select whether to restore the selected primary input source when a primary input source is activated.  The <b>Primary Source Recovery</b> function is disabled if <b>Primary Source</b> is set to <b>All</b> .
	Primary Source	Select a primary source to switch to when no signals are received from the current input.
	Secondary Source	Select a secondary source to switch to when no signals are received from the current input.  The <b>Secondary Source</b> function is disabled if <b>Primary Source</b> is set to <b>All</b> .
	Default Input	Select the default input to switch to when the new input is disconnected. The <b>Last Input</b> option only includes external inputs connected through cables.  <b>Auto Source Switching</b> must be set to <b>New Input</b> to enable the <b>Default Input</b> option.
Power Control	Auto Power On	This feature automatically turns on the product as soon as it is plugged in. Pressing the power button is not needed.
	Max. Power Saving	Conserve power by turning off PC monitor when PC is not used for certain time.
	Standby Control	When no signal is detected, it determines whether or not to enter sleep mode.
	Remote Configuration	Keep the network connection active when the product is turned off.
	Power Button	The power button on the remote control  can be set to turn on the power or turn on or off the power.







2nd	3rd	Description
Power and Energy Saving	Energy Saving Solution	Reduce power consumption by adjusting brightness settings.
	Backlight Optimisation	<p>Automatically adjust the screen brightness based on the ambient light level.</p> <ul style="list-style-type: none"> <li><b>Minimum Brightness:</b> Set the minimum brightness for the signage screen. This function only works if its value is lower than the value set in the <b>Picture</b> menu's <b>Backlight</b> setting.</li> </ul> <p> This function may not be supported depending on the model.</p>
	Backlight Schedule	Adjust panel brightness by schedule. The closer to 100, the brighter the panel.
	No Signal Power Off	<p>Save power by turning the product off when no signal is received from any source.</p> <p> This function does not operate if the display is in the standby mode.</p> <p> The product will automatically power off at a specified time. The time can be changed as required.</p>
	Auto Power Off	Choose how long the display will wait before turning off after no user interaction is detected.
SmartThings Settings		<p>Register the screen to SmartThings.</p> <p>The connected screen can be easily controlled or set by SmartThings.</p>



2nd	3rd	Description
<b>External Device Manager</b>		Manage external devices connected to your signage.
	<b>Input Device Manager</b>	<p>Set up input devices (keyboard or mouse) to use with your display device. You can add input devices and configure settings.</p> <p> Available for Bluetooth enabled models only.</p> <ul style="list-style-type: none"> <li>• <b>Bluetooth Device List</b> Connect a Bluetooth keyboard, mouse or gamepad to your product.</li> <li>• <b>Keyboard Settings</b> Configure the connected keyboard settings. <ul style="list-style-type: none"> <li>– <b>Keyboard Language</b> Set the language of your keyboard.</li> <li>– <b>Keyboard type</b> Set the type of your keyboard.</li> </ul> </li> <li>• <b>Mouse Settings</b> Configure the connected mouse settings. <ul style="list-style-type: none"> <li>– <b>Primary Button</b> Select the button you want to use as the primary button to click and select.</li> <li>– <b>Pointer Speed</b> Set the speed of the mouse pointer.</li> </ul> </li> </ul>
	<b>Device Connection Manager</b>	<p>Allow devices, like phones and tablets, on your network to share content with your product.</p> <ul style="list-style-type: none"> <li>• <b>Access Notification</b> Display a notification when a device such as a smartphone or tablet, is connected. If you use a Wi-Fi network that requires a password, turn off this option to automatically connect with devices without viewing notifications.</li> <li>• <b>Device List</b> View and manage connected devices.</li> </ul>

---





2nd	3rd	Description
<a href="#">Play via</a>		Select the appropriate <a href="#">Play via</a> mode depending on the environment where you are using the product. The home screen may be different depending on the setting.
<a href="#">Change PIN</a>		Change your 6-digit Personal Identification Number (PIN). Choose any 6 digits for your PIN and enter it in <a href="#">Enter a new PIN..</a> Reenter the same 6 digits in <a href="#">Enter the PIN again..</a> The product has memorised your new PIN.  <a href="#">Change the PIN to keep your device secure.</a>

---

2nd	3rd	Description
<b>Security</b>		<p> Enter your 6 digit PIN number. If you want to change the PIN number, use the <b>Change PIN</b> function.</p> <p> Change the PIN to keep your device secure.</p>
	<b>Safety Lock On</b>	<p>Turn <b>Safety Lock On</b> on or off. <b>Safety Lock On</b> restricts the actions that can be carried out by the remote control. The correct PIN must be entered to turn <b>Safety Lock On</b> off.</p> <ul style="list-style-type: none"> <li>• <b>Power On Button</b> Turn on this feature to enable the remote control's Power button to turn on the product while <b>Safety Lock On</b> is enabled.</li> </ul>
	<b>Button Lock</b>	<p>This menu can be used to lock the buttons on the product.</p> <p>Only the remote control can control the product if <b>Button Lock</b> is set to <b>On</b>.</p>
	<b>Screen Monitoring Lock</b>	<p>Blocks screen images from being monitored by MagicINFO Server.</p>
	<b>USB Auto Play Lock</b>	<p>Select whether to automatically play <b>MagicInfo</b> or <b>MagicInfo Lite</b> content saved on a connected USB device.</p> <p> Your content should be a <b>Published Content</b>  that is authored by using <b>MagicInfo Premium</b> application and published to the USB device you are using. The <b>MagicInfo Premium</b> application programme is available on the website. (<a href="http://www.samsung.com/business">http://www.samsung.com/business</a>)</p> <p> When published to a USB device, your <b>Published Content</b>  is saved to <b>Contents</b> and <b>Schedules</b> folders in the root folder of the connected USB device.</p> <p> Connecting a USB device containing <b>MagicInfo</b> or <b>MagicInfo Lite</b> content displays "<b>USB Auto Play Lock : On</b>" for five seconds.</p>
	<b>Mobile Connection Lock</b>	<p>Restrict other devices on your network, such as smart phones and tablets, to prevent them from sharing content on the product.</p> <ul style="list-style-type: none"> <li>• <b>Screen Mirroring Standby</b> Turn on this option to receive connection requests from any source type.</li> </ul>

2nd	3rd	Description
Security	Remote Management	You can <b>Allow</b> or <b>Deny</b> external commands to access your product through a network.
	Secured Protocol	Secure the protocol between this device and other devices. <ul style="list-style-type: none"> <li>• <b>SNMP Settings</b> Set up your ID and password for the SNMP connection.</li> </ul>
	Server Security Status	You can view the MagicINFO server information.  This function is enabled when connected to MagicINFO or RM server.
	Network Lock	Block external network access. You can register networks on the server to allow access.
	USB Lock	Block connection to external USB ports.
	Certificate Manager	Manage the certificates installed on this device.  Limited supports for Enterprise WPA2 (TLS/TLS/PEAP) certified models only. <ul style="list-style-type: none"> <li>• <b>App Certificate</b> View and manage the app certificates installed on this device. Connect a USB flash drive that contains certificates to install them on this device.</li> <li>• <b>Network Certificate</b> View and manage the network certificates installed on this device.</li> </ul>
	Wired 802.1x Connection	To turn on the <b>Wired 802.1x Connection</b> feature, set it to <b>On</b> .







---

2nd	3rd	Description
General	Anynet+ (HDMI-CEC)	<p>Anynet+ is a function that enables you to control all connected Samsung devices that support Anynet+ with your Samsung product remote control. The Anynet+ system can be used only with Samsung devices that have the Anynet+ feature. To be sure your Samsung device has this feature, check if there is an Anynet+ logo on it.</p> <ul style="list-style-type: none"><li> You can only control <b>Anynet+</b> devices using the product remote control, not the buttons on the product.</li><li> The product remote control may not work under certain conditions. If this occurs, reselect the <b>Anynet+</b> device.</li><li> <b>Anynet+</b> works when the AV device supporting <b>Anynet+</b> is in the standby or on status.</li><li> <b>Anynet+</b> supports up to 12 AV devices in total. Note that you can connect up to 3 devices of the same type.</li></ul>

---

## Troubleshooting for Anynet+

Problem	Possible Solution
Anynet+ does not work.	<ul style="list-style-type: none"> <li>• Check if the device is an Anynet+ device. The Anynet+ system supports Anynet+ devices only.</li> <li>• Check if the Anynet+ device power cord is properly connected.</li> <li>• Check the Anynet+ device's Video/Audio/HDMI cable connections.</li> <li>• Check whether <b>Anynet+ (HDMI-CEC)</b> is set to <b>On</b> in the <b>System</b> menu.</li> <li>• Check whether the remote control is Anynet+ compatible.</li> <li>• Anynet+ doesn't work in certain situations. (initial setup)</li> <li>• If you have removed and then reconnected the HDMI cable, please make sure to search devices again or turn your product off and on again.</li> <li>• Check if the Anynet+ function of the Anynet device is set on.</li> </ul>
I want to start Anynet+.	<ul style="list-style-type: none"> <li>• Check if the Anynet+ device is properly connected to the product and check if the <b>Anynet+ (HDMI-CEC)</b> is set to <b>On</b> in the <b>System</b> menu.</li> </ul>
I want to exit Anynet+.	<ul style="list-style-type: none"> <li>• Press the  button on the product remote control and select a non- Anynet+ device.</li> </ul>
The message " <b>Disconnecting Anynet+ device ...</b> " appears on the screen.	<ul style="list-style-type: none"> <li>• You cannot use the remote control when you are configuring Anynet+ or switching to a view mode.</li> <li>• Use the remote control after the product has completed Anynet+ configuration or has finished switching to Anynet+.</li> </ul>
The Anynet+ device does not play.	<ul style="list-style-type: none"> <li>• You cannot use the play function when initial setup is in progress.</li> </ul>
The connected device is not displayed.	<ul style="list-style-type: none"> <li>• Check whether or not the device supports Anynet+ functions.</li> <li>• Check whether or not the HDMI cable is properly connected.</li> <li>• Check whether <b>Anynet+ (HDMI-CEC)</b> is set to <b>On</b> in the <b>System</b> menu.</li> <li>• Search Anynet+ devices again.</li> <li>• Anynet+ requires an HDMI connection. Make sure the device is connected to your product with an HDMI cable.</li> <li>• Some HDMI cables may not support Anynet+ functions.</li> <li>• If the connection is terminated because there has been a power failure or the HDMI cable has been disconnected, please repeat the device scan.</li> </ul>

2nd	3rd	Description
General	HDMI Hot Plug	This feature is used to activate the time delay to turn on a HDMI source device.
	Custom Logo	<p>You can download, select, and set the display time of a custom logo that appears when the product turns on.</p> <ul style="list-style-type: none"> <li>• <b>Custom Logo</b> <ul style="list-style-type: none"> <li> You can select a custom logo (image/video) or turn off the custom logo display.</li> <li> You must download the custom logo from an external USB device to set the custom logo.</li> </ul> </li> <li>• <b>Logo Display Time</b> <ul style="list-style-type: none"> <li> If the type of custom logo is <b>Image</b>, you can set the <b>Logo Display Time</b>.</li> </ul> </li> <li>• <b>Download Logo File</b> <ul style="list-style-type: none"> <li> You can download a custom logo into the product from an external USB device.</li> <li> The file name of the custom logo you want to download must be saved as “samsung” in all small letters.</li> <li> When there are multiple numbers of external USB connections, the product will attempt to download the custom logo from the last device that has been connected to the product.</li> </ul> </li> </ul> <div style="border: 1px solid black; padding: 5px; margin-top: 10px;"> <p>Custom logo file restrictions</p> <ul style="list-style-type: none"> <li>• Images up to 50 MB in size can be used. <ul style="list-style-type: none"> <li>– Supported image file: samsung_image.*</li> <li>– Supported file extensions: jpg, jpeg, bmp, png</li> </ul> </li> <li>• Videos up to 150 MB in size can be used. The recommendation is under 20 seconds in length. <ul style="list-style-type: none"> <li>– Supported video file: samsung_video.*</li> <li>– Supported file extensions: avi, mpg, mpeg, mp4, ts, wmv, asf</li> </ul> </li> </ul> </div>





2nd	3rd	Description
General	Adaptive Picture	<p>Optimises brightness and provides the best picture quality in real time, based on the light level of the surrounding environment.</p> <p>When this function is on, some picture settings are not supported.</p> <p> This function may not be supported depending on the model.</p>
	Empty Storage	Delete files to make space for new content. Recently played files will not be deleted.
Reset System		Reset all system settings to default.

---

# Support

2nd	3rd	Description
<b>Software Update</b>		<p>The <b>Software Update</b> menu lets you upgrade your product software to the latest version.</p> <ul style="list-style-type: none"><li>✎ Be careful not to turn off the power until the upgrade is complete. The product will turn off and on automatically after completing the software upgrade.</li><li>✎ When you upgrade software, all video and audio settings you have made will return to their default settings. We advise you to write down your settings so that you can easily reset them after the upgrade.</li></ul>
	<b>Update Now</b>	<p>Update the software to the latest version.</p> <ul style="list-style-type: none"><li>✎ <b>Current version:</b> This is the software version already installed in the product.</li><li>• Updating through USB Device</li></ul> <p>Download the update package from Samsung's website to a USB storage device and then connect the device to the product to update the product's software.</p> <ul style="list-style-type: none"><li>✎ Remember to save the update package to the top-most directory of the USB device. Otherwise, the product will not be able to find the update package.</li><li>• Updating through the network</li><li>✎ This function can be run when the network is connected properly.</li></ul>

---

2nd	3rd	Description
<a href="#">Contact Samsung</a>		<p>You can view the address of the Samsung website, the call centre phone number, your product's model number, software version, Open Source Licence and other information.</p> <p> Go to <a href="#">Contact Samsung</a> and find the product <a href="#">Model Code</a> and <a href="#">Software Version</a>.</p>
<a href="#">Terms &amp; Privacy</a>		<p>View and set the privacy policy for MagicInfo and other services.</p> <p> Make sure that the product is connected to the network.</p> <p> Menu items may vary depending on the model.</p> <p> The availability may vary depending on the region.</p> <p> This feature is enabled only when "Smart Signage Privacy Notice" is selected during setup.</p>
<a href="#">Device Care</a>		<p>Optimise and diagnose the condition of your Signage. You can check and clean your storage space, diagnose problems or request technical support.</p>
<a href="#">Reset All</a>		<p>This option returns all the current settings for a display to the default factory settings.</p>

# Chapter 07

## Troubleshooting Guide

### Requirements Before Contacting Samsung Customer Service Centre

---

 Follow the instruction on the right to test your product before requesting for service. If the problem persists, contact Samsung Customer Service Centre.

 The power indicator may not be supported depending on the model.

#### Testing the Product

Check if your product is operating normally by using the product test function.

If the screen remains blank while the power indicator blinks even when the product is correctly connected to a PC, perform product testing.

- 1 Power off both the PC and product.
- 2 Disconnect all the cables from the product.
- 3 Power on the product.
- 4 If **No Cable Connected** is displayed, the product is operating normally.

If the screen remains blank, check the PC system, video controller and cable.

#### Checking the Resolution and Frequency

For modes that exceed the supported resolutions, the message "**Not Optimum Mode**" appears briefly.

Refer to Preset Timing Modes to set the PC resolution for your model.

## Check the followings.

Installation issue (PC mode)	
The screen keeps switching on and off.	Check that the cable between the product and the PC is connected correctly.
Blank spaces are found on all four sides of the screen when an HDMI cable is connected to the product and PC.	The blank spaces found on the screen have nothing to do with the product.
	Blank spaces on the screen are caused by the PC or graphics card. To resolve the problem, adjust the screen size in the HDMI settings for the graphics card.
	If the graphics card settings menu does not have an option to adjust the screen size, update the graphics card driver to the latest version. (Please contact the graphics card or computer manufacturer for further details about how to adjust the screen settings.)
Screen issue	
The power indicator is off. The screen will not turn on.	Make sure that the power cord is connected.
No Signal is displayed on the screen.	Check that products (including source device) are connected correctly with a cable.
	Check that the source device connected to the product is powered on.
	Depending on the type of external device, the screen may not display properly. In this case, connect it with the <b>HDMI Hot Plug</b> function turned <b>On</b> .  It is recommended to use the 2.0 gender for the USB Type-C adapter (gender type). In this case, pull out the gender and then connect it again. When the problem persists, contact the gender manufacturer.
Not Optimum Mode is displayed.	This message is displayed when a signal from the graphics card exceeds the product's maximum resolution and frequency.
	Refer to the Standard Signal Mode Table and set the maximum resolution and frequency according to the product specifications.

 The power indicator may not be supported depending on the model.

 The power indicator may not be supported depending on the model.

Screen issue	
The images on the screen look distorted.	Check the cable connection to the product.
The screen is not clear. The screen is blurry.	Set the resolution and frequency to the recommended level.
The screen appears unstable and shaky.	Check that the resolution and frequency of the PC and graphics card are set within a range compatible with the product. Then, change the screen settings if required by referring to 'Preset Timing Modes'.
There are shadows or ghost images left on the screen.	
The screen is too bright. The screen is too dark.	Go to <b>Settings</b> → <b>Picture</b> and adjust the <b>Brightness</b> and <b>Contrast</b> settings.
Screen colour is inconsistent.	Go to <b>Settings</b> → <b>Picture</b> → <b>Advanced Settings</b> and adjust the <b>Colour Space Settings</b> settings.
White does not really look white.	Go to <b>Settings</b> → <b>Picture</b> → <b>Advanced Settings</b> and adjust the <b>White Balance</b> settings.
There is no image on the screen and the power indicator blinks every 0.5 to 1 second.	The display is turned off to save energy.
	Press any key on the keyboard or move the mouse to return to the previous screen.
The product will turn off automatically.	If a PC is connected to the product, check the power status of the PC.
	Make sure the power cord is connected properly to the product and power outlet.
	If the signal from a connected device is not detected, the product automatically turns off after 10 to 15 minutes.
The screen display does not look normal.	Encoded video content may cause the display to appear corrupted in scenes featuring fast moving objects such as in a sports event or action video.
	Low signal level or low picture quality may cause the display to appear corrupted. This does not mean the product is defective.
	A phone within a distance of one-meter radius may cause static on analogue and digital products.

Screen issue	
The brightness and colour do not look normal.	Go to <b>Settings</b> → <b>Picture</b> and adjust the screen settings such as <b>Colour</b> , <b>Brightness</b> and <b>Sharpness</b> .
	Go to <b>Settings</b> → <b>System</b> and adjust the <b>Power and Energy Saving</b> settings.
	Reset the screen settings to the default settings. ( <a href="#">P.66</a> )
I see red, green, and blue.	Check the cable connections.
	This issue may happen when the panel of the product is defective. Contact a Samsung Service Centre to resolve the issue.
The display looks unstable and then freezes.	The screen may freeze when a resolution other than the recommended resolution is used or if the signal is not stable. To resolve the issue, change the PC resolution to the recommended resolution.
The screen cannot be displayed in full screen.	A scaled SD (4:3) content file can cause black bars on both sides of an HD channel screen.
	A video with an aspect ratio different from the product can cause a black bar to appear at the top and bottom of the screen.
	Change the screen size setting to full screen on the product or source device.
Sound issue (For models with built-in speakers)	
There is no sound.	Check the connection of the audio cable or adjust the volume.
	Check the volume.
The volume is too low.	Adjust the volume.
	If the volume is still low after turning it up to the maximum level, adjust the volume on your PC sound card or software.

### Sound issue (For models with built-in speakers)

Video is available but there is no sound.	If an HDMI cable or a DP cable is connected, check the audio output settings on the PC.
	Go to <b>Settings</b> → <b>Sound</b> and change <b>Sound Output</b> to <b>Internal</b> .
	If a source device is used
	<ul style="list-style-type: none"><li>• Make sure the audio cable is properly connected to the audio input port on the product.</li><li>• Check the audio output settings for the source device. (For example, if your monitor is connected to HDMI, you may need to change the audio option of your video output device to HDMI.)</li></ul>
	If the product has a headphone port, make sure nothing is connected to it.
	Reconnect the power cord to the device and then restart the device.
There is static coming from the speakers.	Check the cable connection. Make sure a video cable is not connected to an audio input port.
	Check the signal strength after connecting a cable.
	Low signal level can cause corrupted sound.

### Remote control issue

The remote control does not work.	Make sure that the batteries are correctly in place (+/-).
	Check if the batteries are flat.
	Check for power failure.
	Make sure that the power cord is connected.
	Check for any special lighting or neon signs switched on in the vicinity.

Source device issue	
A beeping sound is heard when my PC is booting.	If a beeping sound is heard when your PC is booting, have your PC serviced.
Other issue	
The product smells like plastic.	The plastic smell is normal and disappears over time.
The monitor appears tilted.	Remove and then attach the stand again to the product.
Audio or video cuts out intermittently.	Check the cable connection and connect it again if required.
	Use a standard cable.
Small particles are found on the edges of the product.	The particles are part of the product design. The product is not defective.
When I try to change the PC resolution, a message "The defined resolution is not supported." appears.	The message "The defined resolution is not supported." appears if the input source resolution exceeds the maximum resolution of the display. To resolve the issue, change the PC resolution to a resolution supported on the display.
HDMI Black Level is not functioning properly on an external device with HDMI YCbCr output.	This function is available only when a source device with RGB signal, such as a DVD player and STB, is connected to the product to HDMI cable.

Other issue	
There is no sound in HDMI mode.	<p>Displayed picture colours may not look normal. Video or sound may not be available. This can occur if a source device that only supports an older version of the HDMI standard is connected to the product.</p> <p>If these issues occur, connect an audio cable along with the HDMI cable.</p> <p>Some PC graphics cards may not automatically recognise HDMI signals that do not include sound. In this case, manually select a sound input.</p>
HDMI-CEC does not work.	<p>To use several external devices compatible with the HDMI-CEC feature that are connected to the HDMI ports on the product, turn off the HDMI-CEC features on all the external devices. External devices include Blu-ray and DVD players.</p> <p>Operating an external device when its HDMI-CEC feature is enabled may automatically stop other external devices.</p> <p>To change HDMI-CEC settings, refer to the device user guide or contact the device manufacturer for assistance.</p>
In power-saving mode, when the input source is <b>DisplayPort</b> , PC display settings cannot be saved.	Go to <b>Settings</b> → <b>System</b> → <b>Power Control</b> and set <b>Max. Power Saving</b> to <b>Off</b> . Alternatively, configure the PC display output settings again. Ensure the product is turned on.
When booting the PC with the input source set to <b>DisplayPort</b> , the BIOS and booting screens do not appear.	Boot the PC when the product is turned on or when the input source is not <b>DisplayPort</b> .

 For models with the DisplayPort port only.

# Chapter 08

## Specifications

### General

Model Name		SM32HX-P	SM55HX-P	SM85HX-P
Panel	Size	32 Class (31.5 inches / 80.1 cm)	55 Class (54.6 inches / 138.7 cm)	85 Class (84.5 inches / 214.7 cm)
	Display area	698.4 mm (H) x 392.85 mm (V)	1209.6 mm (H) x 680.4 mm (V)	1872.0 mm (H) x 1053.0 mm (V)
Resolution (Panel Spec)	Optimum resolution	1920 x 1080 @ 60 Hz (HDMI)	3840 x 2160 @ 60 Hz (HDMI)	
	Maximum resolution	1920 x 1080 @ 60 Hz (DisplayPort)	3840 x 2160 @ 60 Hz (DisplayPort)	
Power Supply		Refer to the label at the back of the product as the standard voltage can vary in different countries.		
Environmental considerations	Operating	Temperature: 0 °C to 40 °C (32 °F to 104 °F) * For installing the enclosure, keep the internal temperature at 40 °C or below. Humidity: 10% to 80%, non-condensing		
	Storage	Temperature: -20 °C to 45 °C (-4 °F to 113 °F) Humidity: 5% to 95%, non-condensing * Applicable before the product package is unpacked.		

- 
- Plug-and-Play  
This monitor can be installed and used with any Plug-and-Play compatible systems. Two-way data exchange between the monitor and PC system optimises the monitor settings. Monitor installation takes place automatically. However, you can customise the installation settings if desired.
  - Due to the nature of the manufacturing of this product, approximately 1 pixel per million (1ppm) may appear brighter or darker on the panel. This does not affect product performance.
  - This product can be set to only one resolution for each screen size to obtain the optimum picture quality due to the nature of the panel. Using a resolution other than the specified resolution may degrade the picture quality. To avoid this, it is recommended that you select the optimum resolution specified for your product.
  - For detailed device specifications, visit the Samsung website.
  - (Europe only)  
To access energy labelling information about this product on the European Product Registry for Energy Labelling (EPREL), go to [https://eprel.ec.europa.eu/qr/\\*\\*\\*\\*\\*](https://eprel.ec.europa.eu/qr/*****) where \*\*\*\*\* is the product's EPREL registration number. You can find the registration number on the rating label of your product.
  - (Türkiye only)  
To access the energy labelling information of the model:
    - (1) Go to [https://www.samsung.com/global/ecodesign\\_energy](https://www.samsung.com/global/ecodesign_energy)
    - (2) Get the model identifier from the energy label of the product and type it in the search box
    - (3) Energy labelling information can be found

## Preset Timing Modes

The screen will automatically be adjusted if a signal that belongs to the following standard signal modes is transmitted from your PC. If the signal transmitted from the PC does not belong to the standard signal modes, the screen may be blank with the power indicator on. In such a case, change the settings according to the following table by referring to the graphics card user manual.

### SM32HX-P

Resolution	Horizontal Frequency (kHz)	Vertical Frequency (Hz)	Pixel Clock (MHz)	Sync Polarity (H/V)	Port	
					DP IN	HDMI IN
IBM, 720 x 400	31.469	70.087	28.322	-/+	0	0
MAC, 640 x 480	35.000	66.667	30.240	-/-	0	0
MAC, 832 x 624	49.726	74.551	57.284	-/-	0	0
MAC, 1152 x 870	68.681	75.062	100.000	-/-	0	0
VESA DMT, 640 x 480	31.469	59.940	25.175	-/-	0	0
VESA DMT, 640 x 480	37.861	72.809	31.500	-/-	0	0
VESA DMT, 640 x 480	37.500	75.000	31.500	-/-	0	0
VESA DMT, 800 x 600	37.879	60.317	40.000	+/+	0	0
VESA DMT, 800 x 600	48.077	72.188	50.000	+/+	0	0
VESA DMT, 800 x 600	46.875	75.000	49.500	+/+	0	0
VESA DMT, 1024 x 768	48.363	60.004	65.000	-/-	0	0
VESA DMT, 1024 x 768	56.476	70.069	75.000	-/-	0	0
VESA DMT, 1024 x 768	60.023	75.029	78.750	+/+	0	0
VESA DMT, 1152 x 864	67.500	75.000	108.000	+/+	0	0
VESA DMT, 1280 x 720	45.000	60.000	74.250	+/+	0	0

Resolution	Horizontal Frequency (kHz)	Vertical Frequency (Hz)	Pixel Clock (MHz)	Sync Polarity (H/V)	Port	
					DP IN	HDMI IN
VESA DMT, 1280 x 800	49.702	59.810	83.500	-/+	0	0
VESA DMT, 1280 x 1024	63.981	60.020	108.000	+/+	0	0
VESA DMT, 1280 x 1024	79.976	75.025	135.000	+/+	0	0
VESA DMT, 1366 x 768	47.712	59.790	85.500	+/+	0	0
VESA DMT, 1440 x 900	55.935	59.887	106.500	-/+	0	0
VESA DMT, 1600 x 900RB	60.000	60.000	108.000	+/+	0	0
VESA DMT, 1680 x 1050	65.290	59.954	146.250	-/+	0	0
VESA DMT, 1920 x 1080	67.500	60.000	148.500	+/+	0	0
CTA-861, 720(1440) x 576i	15.625	50.000	27.000	-/-	-	0
CTA-861, 720(1440) x 480i	15.734	59.940	27.000	-/-	-	0
CTA-861, 720 x 576	31.250	50.000	27.000	-/-	0	0
CTA-861, 720 x 480	31.469	59.940	27.000	-/-	0	0
CTA-861, 1280 x 720	37.500	50.000	74.250	+/+	0	0
CTA-861, 1280 x 720	45.000	60.000	74.250	+/+	0	0
CTA-861, 1920 x 1080i	28.125	50.000	74.250	+/+	-	0
CTA-861, 1920 x 1080i	33.750	60.000	74.250	+/+	-	0
CTA-861, 1920 x 1080	27.000	24.000	74.250	+/+	-	0
CTA-861, 1920 x 1080	28.125	25.000	74.250	+/+	-	0
CTA-861, 1920 x 1080	33.750	30.000	74.250	+/+	-	0
CTA-861, 1920 x 1080	56.250	50.000	148.500	+/+	0	0
CTA-861, 1920 x 1080	67.500	60.000	148.500	+/+	0	0

## SM55HX-P / SM85HX-P

Resolution	Horizontal Frequency (kHz)	Vertical Frequency (Hz)	Pixel Clock (MHz)	Sync Polarity (H/V)	Port	
					DP IN	HDMI IN
IBM, 720 x 400	31.469	70.087	28.322	-/+	0	0
MAC, 640 x 480	35.000	66.667	30.240	-/-	0	0
MAC, 832 x 624	49.726	74.551	57.284	-/-	0	0
MAC, 1152 x 870	68.681	75.062	100.000	-/-	0	0
VESA CVT, 3840 x 2160RB	110.500	49.977	442.000	+/-	0	-
VESA CVT, 3840 x 2160RB	133.313	59.997	533.250	+/-	0	-
VESA DMT, 640 x 480	31.469	59.940	25.175	-/-	0	0
VESA DMT, 640 x 480	37.861	72.809	31.500	-/-	0	0
VESA DMT, 640 x 480	37.500	75.000	31.500	-/-	0	0
VESA DMT, 800 x 600	37.879	60.317	40.000	+/+	0	0
VESA DMT, 800 x 600	48.077	72.188	50.000	+/+	0	0
VESA DMT, 800 x 600	46.875	75.000	49.500	+/+	0	0
VESA DMT, 1024 x 768	48.363	60.004	65.000	-/-	0	0
VESA DMT, 1024 x 768	56.476	70.069	75.000	-/-	0	0
VESA DMT, 1024 x 768	60.023	75.029	78.750	+/+	0	0
VESA DMT, 1152 x 864	67.500	75.000	108.000	+/+	0	0
VESA DMT, 1280 x 720	45.000	60.000	74.250	+/+	0	0
VESA DMT, 1280 x 800	49.702	59.810	83.500	-/+	0	0
VESA DMT, 1280 x 1024	63.981	60.020	108.000	+/+	0	0
VESA DMT, 1280 x 1024	79.976	75.025	135.000	+/+	0	0
VESA DMT, 1366 x 768	47.712	59.790	85.500	+/+	0	0
VESA DMT, 1440 x 900	55.935	59.887	106.500	-/+	0	0
VESA DMT, 1600 x 900RB	60.000	60.000	108.000	+/+	0	0
VESA DMT, 1680 x 1050	65.290	59.954	146.250	-/+	0	0

Resolution	Horizontal Frequency (kHz)	Vertical Frequency (Hz)	Pixel Clock (MHz)	Sync Polarity (H/V)	Port	
					DP IN	HDMI IN
VESA DMT, 1920 x 1080	67.500	60.000	148.500	+/+	0	0
VESA DMT, 2560 x 1440RB	88.787	59.951	241.500	+/-	0	0
CTA-861, 720(1440) x 576i	15.625	50.000	27.000	-/-	-	0
CTA-861, 720(1440) x 480i	15.734	59.940	27.000	-/-	-	0
CTA-861, 720 x 576	31.250	50.000	27.000	-/-	0	0
CTA-861, 720 x 480	31.469	59.940	27.000	-/-	0	0
CTA-861, 1280 x 720	37.500	50.000	74.250	+/+	0	0
CTA-861, 1280 x 720	45.000	60.000	74.250	+/+	0	0
CTA-861, 1920 x 1080i	28.125	50.000	74.250	+/+	-	0
CTA-861, 1920 x 1080i	33.750	60.000	74.250	+/+	-	0
CTA-861, 1920 x 1080	27.000	24.000	74.250	+/+	-	0
CTA-861, 1920 x 1080	28.125	25.000	74.250	+/+	-	0
CTA-861, 1920 x 1080	33.750	30.000	74.250	+/+	-	0
CTA-861, 1920 x 1080	56.250	50.000	148.500	+/+	0	0
CTA-861, 1920 x 1080	67.500	60.000	148.500	+/+	0	0
CTA-861, 3840 x 2160	54.000	24.000	297.000	+/+	-	0
CTA-861, 3840 x 2160	56.250	25.000	297.000	+/+	-	0
CTA-861, 3840 x 2160	67.500	30.000	297.000	+/+	0	0
CTA-861, 3840 x 2160	112.500	50.000	594.000	+/+	0	0
CTA-861, 3840 x 2160	135.000	60.000	594.000	+/+	0	0
CTA-861, 4096 x 2160	54.000	24.000	297.000	+/+	-	0
CTA-861, 4096 x 2160	67.500	30.000	297.000	+/+	-	0
CTA-861, 4096 x 2160	112.500	50.000	594.000	+/+	-	0
CTA-861, 4096 x 2160	135.000	60.000	594.000	+/+	-	0

# Chapter 09

## Appendix

### Responsibility for the Pay Service (Cost to Customers)

 When the service is requested, in spite of in warranty, we may charge you for a visit from a service technician in the following cases.

#### Not a product defect

Cleaning of the product, Adjustment, Explanation, Re-installation and etc.

- If a service technician is requested to give instructions on how to use product or simply adjusts options without disassembling product.
- If a defect is caused by external environmental factors (Internet, Antenna, Wired Signal, etc.)
- If a product is reinstalled or devices are connected additionally after installing the purchased product for the first time.
- If a product is reinstalled to move to a different spot or to move to a different house.
- If the customer requests instructions on how to use another company's product.
- If customer requests instructions on how to use the network or another company's programme.
- If customer requests software installation and setup for the product.
- If a service technician removes/cleans dusts or foreign materials inside of the product.
- If customer requests an installation additionally after purchasing a product through home-shopping or online.

### A Product damage caused by customer's fault

Product damage caused by customer's mishandling or wrong repair

If a product damage is caused by;

- External impact or drop.
- Use of supplies or separately sold product unspecified by Samsung.
- Repair from a person besides an engineer of outsourcing service company or partner of Samsung Electronics Co., Ltd.
- Remodeling or repairing the product by customer.
- Using it with incorrect voltage or non-authorized electrical connections.
- Not following the "cautions" in User guide.
- If a malfunction occurs due to iron powder or other conductive metal materials.

#### Others

- If product fails by natural disaster. (lightning, fire, earthquake, flood damage, etc)
  - If consumable components are all used up. (Battery, Toner, Fluorescent lights, Head, Vibrator, Lamp, Filter, Ribbon, etc.)
  - Brightness has decreased due to aging of the product.
  - The product is faulty due to sulphur (S), phosphorus (P) or other chemical substances.
-  If customer requests a service in case the product has no defect, service fee may be charged. So please read User guide first.

## Prevention of Afterimage Burn-in

### What is afterimage burn-in?

Afterimage burn-in should not occur when the panel is operating normally. Normal operation refers to a continuously changing video pattern. If the panel displays a fixed pattern for an extended period of time a slight voltage difference may occur between the electrodes in pixels that control the liquid crystals.

Such a voltage difference between electrodes increases with time and makes the liquid crystals thinner. When this occurs, a previous image can remain on the screen when the pattern changes.

- ⊘ This information is a guide to prevent afterimage burn-in. Viewing a fixed screen for an extended period of time may cause afterimage burn-in. This problem is not included in warranty.

### Recommended prevention practices

Viewing a fixed screen for an extended period of time may cause afterimage burn-ins or smudges. If the product is not to be used for a long time, turn it off, or activate the Power Saving mode or Screen Saver with a moving image.

- Change the colours regularly.



- Avoid combinations of a text colour and background colour of contrasting brightness.
- ✎ Avoid using colours of contrasting brightness (black and white; grey and black).

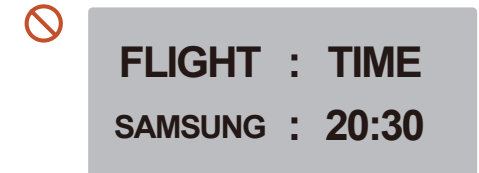
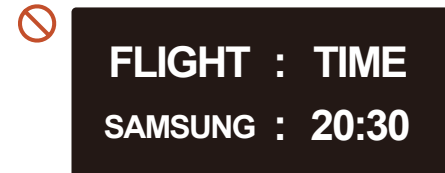

---

## Licence



Dolby, Dolby Audio, Dolby Atmos and the double-D symbol are registered trademarks of Dolby Laboratories Licensing Corporation. Manufactured under license from Dolby Laboratories. Confidential unpublished works. Copyright © 2012-2026 Dolby Laboratories. All rights reserved.



The terms HDMI, HDMI High-Definition Multimedia Interface, HDMI trade dress and the HDMI Logos are trademarks or registered trademarks of HDMI Licensing Administrator, Inc.

---

### Open Source License Notice

Open Source used in this product can be found on the following webpage (<https://opensource.samsung.com>).

---



THIS PRODUCT IS SOLD WITH A LIMITED LICENCE AND IS AUTHORISED TO BE USED ONLY IN CONNECTION WITH HEVC CONTENT THAT MEETS EACH OF THE THREE FOLLOWING QUALIFICATIONS: (1) HEVC CONTENT ONLY FOR PERSONAL USE; (2) HEVC CONTENT THAT IS NOT OFFERED FOR SALE; AND (3) HEVC CONTENT THAT IS CREATED BY THE OWNER OF THE PRODUCT.

THIS PRODUCT MAY NOT BE USED IN CONNECTION WITH HEVC ENCODED CONTENT CREATED BY A THIRD PARTY, WHICH THE USER HAS ORDERED OR PURCHASED FROM A THIRD PARTY, UNLESS THE USER IS SEPARATELY GRANTED RIGHTS TO USE THE PRODUCT WITH SUCH CONTENT BY A LICENSED SELLER OF THE CONTENT.

YOUR USE OF THIS PRODUCT IN CONNECTION WITH HEVC ENCODED CONTENT IS DEEMED ACCEPTANCE OF THE LIMITED AUTHORITY TO USE AS NOTED ABOVE.

---